

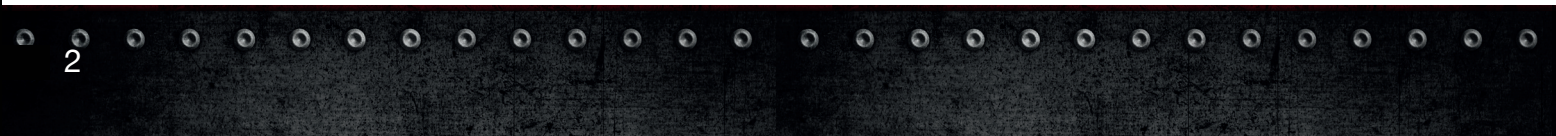

CONSTRUCTION / JOBSITE / WORKSHOP / TOOLS / SAFETY

2024

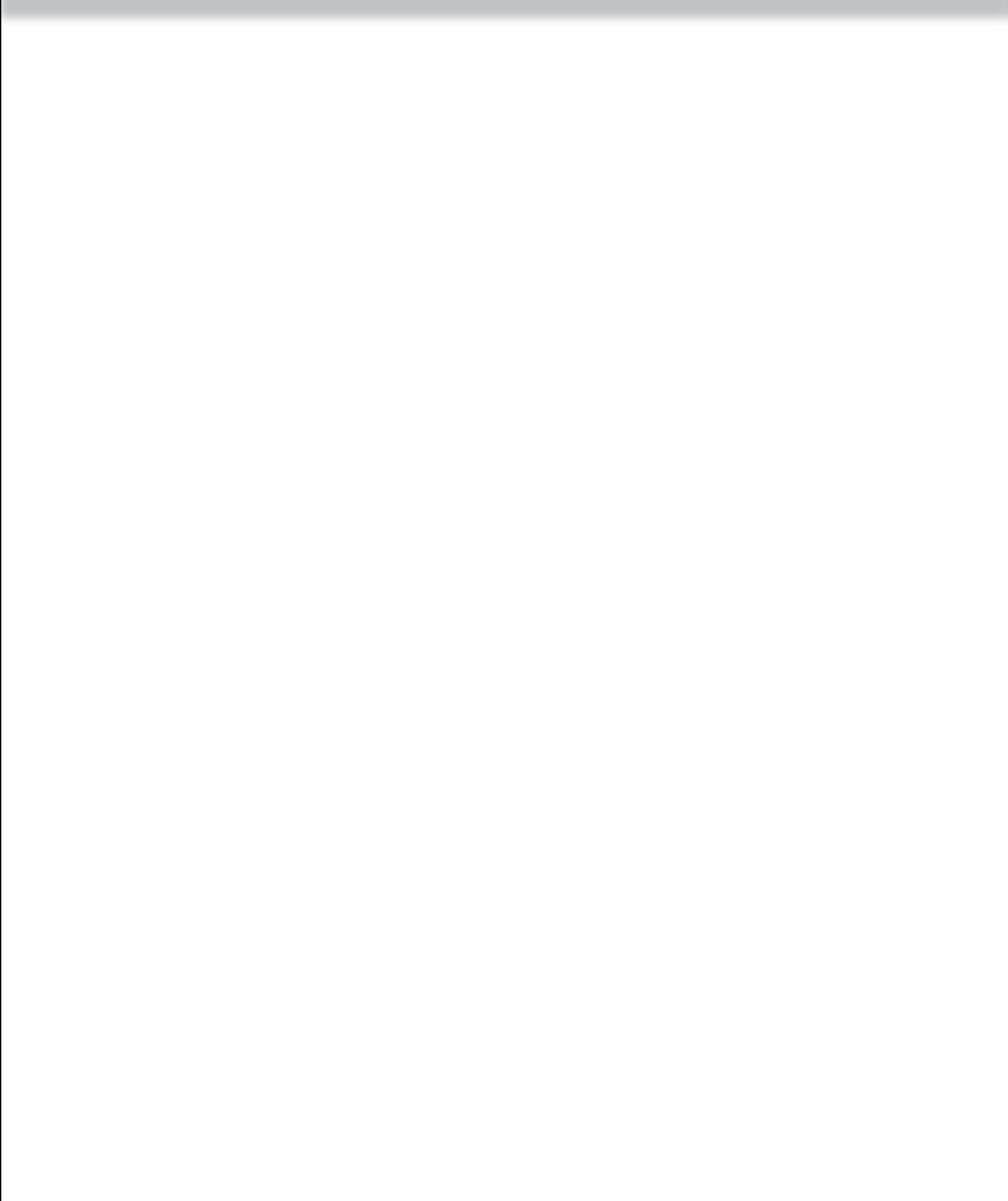

INDEX

CONSTRUCTION / JOBSITE

6
-
33

WORKSHOP / TOOLS

34
-
120

SAFETY

121
-
172

DISPLAYS

173
-
175

DEWALT

JCB

DIGGERS
tools

DIGGERS
workwear

ROTHENBERGER
INDUSTRIAL

STANLEY

 **ROUGHNECK**

SAVAGE
by SWANSON

FTG
safety shoes

CASTLE
CLOTHING 

Astroplast 



SAW HORSES



TROUSERS



SHOES



HAMMERS



HARD WEAR



CLOTHING

CONTACT ECONEX TEAM

Dirk Thienpont

Owner – Purchasing – Export

Mobile: +32 (0) 477 28 13 94

dirk@econex.be

Stan Steyvers

Sales Belgium (Dutch)

Mobile: +32 (0) 476 61 47 42

stan@econex.be

Steve Bruynickx

Sales Belgium (French) – Netherlands

Mobile: +32 (0) 485 41 49 16

steve@econex.be

Rudy Steyvers + Marco De Vriese

Warehouse

service@econex.be

Bouhmidi Redouane

Merchandiser

All rights reserved. Econex reserves the right to improve and develop products in this publication, move or add products without notification and on an ongoing basis. Real textile colours may slightly differ from the printed ones. We reserve the right to improve products in this publication, move or add products without notification and on an ongoing basis.

The most up to date brochure is available for download on our website www.econex.be

Price changes are possible.

All prices are in Euro and are recommended end-user prices, exclusive of VAT.

CONSTRUCTION / JOBSITE

DIGGERS
tools

D814 SAWHORSE / JOBSITE TABLE

€ 64,40

Foldable sawhorses for simple storage and transport
2 beams create a solid workstation table
100% steel construction, powder coated and galvanised surfaces
1 Beam 500 Kg
2 Beams 1000 Kg

EAN 5425009851814



1) CREATE A SOLID JOBSITE TABLE WITH 2 SAWHORSES.



2) SIDES FOR BEAM



3) ANTI-SLIP FEET



4) MATERIAL SUPPORT PEGS



DIGGERS
tools

D838 SAWHORSE / JOBSITE TABLE

€ 77,00

Foldable sawhorses for simple storage and transport
2 beams create a solid workstation table
100% steel construction, powder coated and galvanised surfaces
Adjustable legs for extra stability

1 Beam 600 Kg
2 Beams 1200 Kg

EAN 5425009851838



1) CREATE A SOLID JOBSITE TABLE WITH 2 SAWHORSES.



2) LEGS ADJUSTABLE IN HEIGHT



3) ANTI-SLIP FEET



4) MATERIAL SUPPORT PEGS



SAW HORSES

DIGGERS
tools

D852 SAWHORSE / JOBSITE TABLE

€ 84,00

Foldable sawhorses for simple storage and transport
2 beams create a solid workstation table
100% steel construction, powder coated and galvanised surfaces
Adjustable legs for extra stability
Sides adjustable for different beam thicknesses

1 Beam 600 Kg
2 Beams 1200 Kg

EAN 5425009851852



1) CREATE A SOLID JOBSITE TABLE WITH 2 SAWHORSES.



2) LEGS ADJUSTABLE IN HEIGHT



3) ANTI-SLIP FEET



4) MATERIAL SUPPORT PEGS



5) sides adjustable for different beam thicknesses



DIGGERS
tools

DIG449 PINE WOOD TRESTLE 75 X 75 CM

€ 7,30

Pine wood 75*75 *42*18,
80kg capaciteit

EAN 5425009851449



DIGGERS
tools

DIG 456 SOLID PINE WOOD TRESTLE 75 X 75 CM

€ 11,20

Beech wood 75*75*45*25,
100kg capaciteit

EAN 5425009851456



DIGGERS
tools

DIG 463 SOLID BEECH TRESTLE 75 X 75 CM

€ 10,90

Solid beech
75*75*42*18,
120kg capaciteit

EAN 5425009851463



MORTAR APPLICATOR + LIGHTS

DIGGERS
tools

D0725: MANUAL HAND MORTAR GUN

€ 72,45

Perfect tool to glue bricks, filling grouts, ...
Made from high quality PVC, Lightweight and handy, Simple to use
Easy to clean, Overhead working, 0,9 liters, Length: 75cm

EAN: 5425009850725



DIGGERS
tools

PISTON

€ 15,00

Inside seal

DIGGERS
tools

DIGGERS
tools

MORTAR GLUE APPLICATOR

Easy tool for applying easy glue mortar on Bricks
Made in galvanized steel.
3 sizes (10cm, 14cm and 19cm)

D0978 * 10 CM * EAN: 5425009850978
D0985 * 14 CM * EAN: 5425009850985
D0992 * 19 CM * EAN: 5425009850992

€ 135,00
€ 142,00
€ 155,00

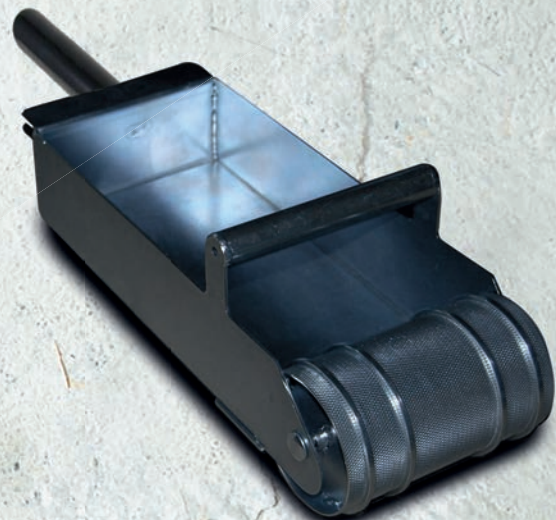

DIGGERS
tools

DIG016

€ 15,90

Lifting, levelling & adjusting: Doors & Windows,
White Goods, Kitchen Units, Cabinets &
Office Equipment, Water Tanks & Radiators, etc.

EAN: 5425009853016



WITH COMPLETE BUILT-IN TECHNOLOGY
WANT 2 PUMP IT UP?

TOOL CABINET

DIGGERS

tools

DIG001: 7 DRAWERS

€ 690,00

5 filled Handily sorted over 7 drawers you will find more than 250 tools for all small jobs and large jobs in this toolbox. Always have everything at hand to solve problems quickly and properly once and for all. All the tools are made of durable chrome vanadium C45 steel and the box is made of powder-coated metal so that this set will last a long time. You can move the toolbox easily thanks to the wheels.

EAN 5425009851111

DIG002: 7 DRAWERS, EMPTY

€ 440,00

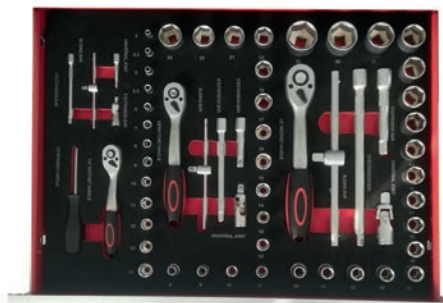
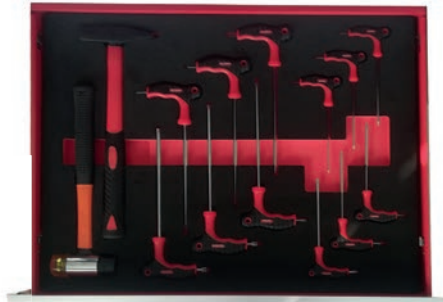
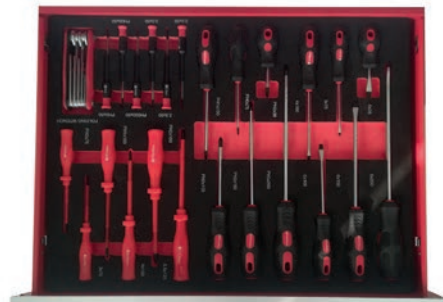

WRECKING BARS - UTILITY BARS



ROUGHNECK®

GORILLA

**TOUGHER™
BY DESIGN**

GORILLA BARS®

THE SHAPE MAKES THE DIFFERENCE

POLISHED TIPS

DROP FORGET

HEAT TREATED

POWDER COATED

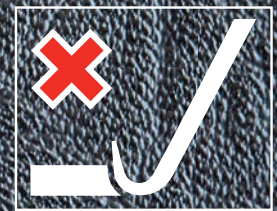
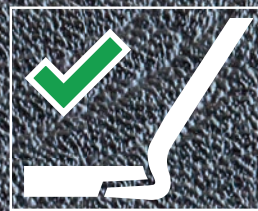

NAIL REMOVER

+50% LEVERAGE

LOW PROFILE

WIDE JAW

POLISHED TIPS



CODE	DESCRIPTION	SIZE	LABEL	BOX	EAN-CODE	PRICE
64-405	GORILLA BAR®	356MM/14"	FLAG	6	0025997 644051	€ 11,52
64-407	GORILLA BAR®	610MM/24"	FLAG	6	0025997 644075	€ 20,78
64-409	GORILLA BAR®	914MM/36"	FLAG	6	0025997 644099	€ 28,05
64-410	GORILLA BAR®	1.2M/48"	FLAG	4	0025997 644105	€ 35,86

ROUGHNECK
GORILLA

BONSAI MOULDING BAR

For removing embedded nails and trim from walls.
This type of bar is: Magnetic, had a Striking face, has a Wide jaw, polished tips, a nail remover x2, is drop forged, has been heat treated and is powder coated.



CODE	DESCRIPTION	SIZE	LABEL	BOX	EAN-CODE	PRICE
64-511	BONSAI MOULDING BAR	250MM/10"	HANGING CARD	6	0025997 645119	€ 21,65

ROUGHNECK
GORILLA

BONSAI CLAW BAR

For removing embedded nails and light prying.
This type of bar is: magnetic, has a striking face, Has polished tips, a nail remover x2, is drop forged, Has been heat treated and is powder coated.



CODE	DESCRIPTION	SIZE	LABEL	BOX	EAN-CODE	PRICE
64-513	BONSAI CLAW BAR	250MM/10"	HANGING CARD	6	0025997 645133	€ 21,65

ROUGHNECK

UTILITY BARS:

These bars have Polished tips, Nail remover x3, Drop forged, Heat treated AND ARE powder coated



CODE	DESCRIPTION	SIZE	LABEL	BOX	EAN-CODE	PRICE
64-494	UTILITY BAR	178MM/7"	LABEL	6	0025997 644945	€ 5,96
64-495	UTILITY BAR	381MM/15"	LABEL	6	0025997 644952	€ 11,35
64-496	UTILITY BAR	457MM/18"	LABEL	6	0025997 644969	€ 12,46

ROUGHNECK

BONSAI CLAW BAR

These bars have Polished tips, Nail remover x3, Drop forged, striking face, Heat treated AND ARE powder coated



CODE	DESCRIPTION	SIZE	LABEL	BOX	EAN-CODE	PRICE
64-497	UTILITY BAR	381MM/15"	HANGING CARD	6	0025997 644976	€ 18,79

DIGGING BARS + BAR SETS

ROUGHNECK

DIGGING BARS

These bars have Polished tips, are Hand forged, are Heat treated AND ARE powder coated.



CODE	DESCRIPTION	SIZE	LABEL	BOX	EAN-CODE	PRICE
64-530	DIGGING BAR - CHISEL AND POINT	1.52M/60"	LABEL	1	0025997 645300	€ 70,52
64-532	DIGGING BAR - CHISEL AND POINT	1.83M/72"	LABEL	1	0025997 645324	€ 87,85
64-549	DIGGING BAR - LONG CHISEL AND TAMPER	1.75M/69"	LABEL	1	0025997 645492	€ 88,76
64-562	DIGGING BAR - WIDE CHISEL AND POINT	2.08M/82"	LABEL	1	0025997 645621	€ 144,19
64-585	DIGGING BAR - BENT CHISEL AND POINT	1.52M/60"	LABEL	1	0025997 645850	€ 78,32



ROUGHNECK

TOOLBOX BAR SET - 4 PIECES

A four piece collection of handy sized bars, the Toolbox Bar Set contains all the bars you'll ever need for light to medium prying work.

Polished tips (1, 2, 4), Nail remover, Soft grip (2).
Drop forged, Heat treated, Powder coated.



CODE	DESCRIPTION	LABEL	BOX	EAN-CODE	PRICE
64-950	TOOLBOX BAR SET - 4 PIECE BAR SET	HANGING CARD	6	5057902649504	€ 36,13
1	UTILITY BAR	330MM/13"			
2	NAIL PULLER	230MM/9"			
3	FLOORBOARD PULLER	260MM/10 1/4"			
4	MINI UTILITY BAR	190MM/7 1/2"			



ULTIMATE MULTI-PURPOSE BAR SET - 5 PIECES

These bars have +50% leverage power, are low profile, have a wide jaw, have polished tips, a nail remover, are drop forged, are heat treated and powder coated.



+50% LEVERAGE



CODE	DESCRIPTION	LABEL	BOX	EAN-CODE	PRICE
64-961	ULTIMATE MULTI-PURPOSE BAR SET - 5 PIECE BAR SET	DISPLAY BOX	4	0025997 649612	€ 45,86
1	UTILITY BAR - 330MM/13"	+50% LEVERAGE POWER (5)	POLISHED TIPS	HEAT TREATED	
2	WRECKING BAR - 381MM/15"	LOW PROFILE (5)	NAIL REMOVER	POWDER COATED	
3	WRECKING BAR - 305MM/12"	WIDE JAW (5)	DROP FORGED		
4	UTILITY BAR - 178MM/7"				
5	GORILLA BAR - 356MM/14"				



MULTI-PURPOSE BAR SET - 5 PIECES

These bars have have +50% leverage power, are low profile, have polished tips, a nail remover, are drop forged, are heat treated and powder coated.



CODE	DESCRIPTION	LABEL	BOX	EAN-CODE	PRICE
64-965	MULTI-PURPOSE BAR SET- 5 PIECE	DISPLAY BOX	4	5057902 649658	€ 65,05
64-965 SFDI	MULTI-PURPOSE BAR SET - 5 PIECE	MAILER BOX	6	0025997 649650	€ 65,05
1	UTILITY BAR - 178MM/7"	POLISHED TIPS	HEAT TREATED		
2	UTILITY BAR - 381MM/15"	NAIL REMOVER (1, 2, 4, 5)	POWDER COATED		
3	ALIGNING BAR - 610MM/24"	DROP FORGED			
4	WRECKING BAR - 457MM/18"				
5	WRECKING BAR - 305MM/12"				



GORILLA BAR® SET - 2 AND 3 PIECES

ROUGHNECK
GORILLA

GORILLA BAR® SET - 2 PIECES

These bars have +50% leverage power, are low profile, have a wide jaw, have polished tips, a nail remover, are drop forged, are heat treated and powder coated.



+50% LEVERAGE



CODE	DESCRIPTION	SIZE	LABEL	BOX	EAN-CODE	PRICE
64-400	GORILLA BAR® SET - 2 PIECE	356MM/14", 610MM/24"	HANGING CARD	5	0025997 644006	€ 31,20
	1 GORILLA BAR® - 610MM/24"					
	2 GORILLA BAR® - 356MM/14"					

ROUGHNECK
GORILLA

GORILLA BAR® SET - 3 PIECES

These bars have +50% leverage power, are low profile, have a wide jaw, have polished tips, a nail remover, are drop forged, are heat treated and powder coated.



+50% LEVERAGE



CODE	DESCRIPTION	SIZE	LABEL	BOX	EAN-CODE	PRICE
64-401	GORILLA BAR® SET - 3 PIECE	356MM/14", 610MM/24", 914MM/36"	DISPLAY BOX	4	0025997 644013	€ 57,24
	1 GORILLA BAR® - 914MM/36"					
	2 GORILLA BAR® - 610MM/24"					
	3 GORILLA BAR® - 356MM/14"					



ROOFING TOOLS

**ROUGHNECK
GORILLA**

ROOFING BAR AND HAMMER

These bars have +50% leverage power, have a striking face, a hammer function, are low profile, have a wide jaw, a nail remover, have polished tips, are drop forged, are heat treated and powder coated.

NEW



+50% LEVERAGE POWER



CODE	DESCRIPTION	SIZE	LABEL	BOX	EAN-CODE	PRICE
64-403	ROOFING BAR AND HAMMER	432MM/17"	FLAG	6	0025997644037	€ 20,05



PRY & WRECKING TOOLS

**ROUGHNECK
GORILLA**

ADJUSTABLE GORILLA BAR

These bars enable the optimal angle for maximum leverage power, have 180° rotation, have an oval profile, are easily adjustable by the push button, are low profile, have a wide claw, a nail remover, have polished tips, are drop forged, are heat treated and powder coated.

NEW



CODE	DESCRIPTION	SIZE	WEIGHT	EAN-CODE	PRICE
64-417	ADJUSTABLE GORILLA BAR	610MM/24"	-	5057902644172	€ 63,26



CLUB HAMMERS + DEMOLITION AND LIFTING BAR

**ROUGHNECK
GORILLA**

DEMOLITION AND LIFTING BAR

Ideal for ripping up floorboards,
Lifting and positioning heavy objects,
And general demolition work

Low profile claws, one-handed operation
Soft grip, drop forged, heat treated,
Powder coated



CODE	DESCRIPTION	LABEL	BOX	EAN-CODE	PRICE
64-640	DEMOLITION AND LIFTING BAR	FLAG	1	0025997 646406	€ 43,67

**ROUGHNECK
GORILLA**

ROOFING DEMOLITION AND LIFTING BAR

Ideal for working overhead, taking down ceilings,
removing roof laths, and working in confined spaces

Low profile claws, one-handed operation
Soft grip, drop forged, heat treated,
Powder coated



CODE	DESCRIPTION	LABEL	BOX	EAN-CODE	PRICE
64-642	ROOFING DEMOLITION AND LIFTING BAR	FLAG	6	0025997 646420	€ 39,93

**ROUGHNECK
GORILLA**

GORILLA CLUB HAMMER

Dome-shaped point, extra large face, 45° chamfered edges
Fence post striking face x2, solid fibreglass core
Compression fit handle, shock absorbing grip, lanyard hole
Drop forged, induction hardened



CODE	DESCRIPTION	SIZE	LABEL	BOX	EAN-CODE	PRICE
65-703	CLUB HAMMER	1.4KG/3LBS	SWING TAG	4	0025997 657037	€ 31,61
65-704	CLUB HAMMER	1.8KG/4LBS	SWING TAG	4	0 025997 657044	€ 36,40

ROUGHNECK

CLUB HAMMER

Polished faces, 45° chamfered edges, solid fibreglass core, soft grip
Lanyard hole, drop forged, heat treated, painted head



CODE	DESCRIPTION	SIZE	LABEL	BOX	EAN-CODE	PRICE
61-502	CLUB HAMMER	1.1KG/2½LBS	SWING TAG	4	0025997 615020	€ 26,70
61-504	CLUB HAMMER	1.8KG/4LBS	SWING TAG	4	0025997 615044	€ 29,40

SLEDGE HAMMERS

ROUGHNECK
GORILLA

SLEDGE HAMMER

Unique shape for outstanding versatility and performance.
Dome-shaped point, induction hardened, drop forged
Fence post striking face x2, compression fit handle
solid fibreglass core, shock absorbing grip,
extra large face, 5° chamfered edges.



CODE	DESCRIPTION	SIZE	LABEL	BOX	EAN-CODE	PRICE
65-906	SLEDGE HAMMER	2.7KG/6LBS	SWING TAG	2	0025997 659062	€ 66,65
65-908	SLEDGE HAMMER	3.6KG/8LBS	SWING TAG	2	0025997 659086	€ 74,97
65-910	SLEDGE HAMMER	4.5KG/10LBS	SWING TAG	2	0025997 659109	€ 83,33
65-912	SLEDGE HAMMER	5.5KG/12LBS	SWING TAG	2	0025997 659123	€ 100,01

ROUGHNECK

SLEDGE HAMMER

Milled convex faces, 45° chamfered edges
Overstrike protection, solid fibreglass core
Soft grip, drop forged, heat treated
Painted head



CODE	DESCRIPTION	SIZE	LABEL	BOX	EAN-CODE	PRICE
65-627	SLEDGE HAMMER	2.7KG/6LBS	SWING TAG	2	0025997 656276	€ 55,91
65-631	SLEDGE HAMMER	3.6KG/8LBS	SWING TAG	2	0025997 656313	€ 64,37
65-633	SLEDGE HAMMER	4.5KG/10LBS	SWING TAG	2	0025997 656337	€ 71,17
65-634	SLEDGE HAMMER	5.5KG/12LBS	SWING TAG	2	0025997 656344	€ 83,86
65-635	SLEDGE HAMMER	6.4KG/14LBS	SWING TAG	2	0025997 656351	€ 90,64
65-636	SLEDGE HAMMER	7.3KG/16LBS	SWING TAG	2	0025997 656368	€ 99,11

GORILLA MINI SLEDGE HAMMER

ROUGHNECK
GORILLA

Unique shape for outstanding versatility and performance.
Dome-shaped point, extra large face, 45° chamfered edges
Fence post striking face x2, solid fibreglass core
Compression fit handle, shock absorbing grip
Lanyard hole, drop forged, induction hardened



CODE	DESCRIPTION	SIZE	LABEL	BOX	EAN-CODE	PRICE
65-803	MINI SLEDGE HAMMER	1.4KG/3LBS	SWING TAG	2	0025997 658034	€ 35,95
65-804	MINI SLEDGE HAMMER	1.8KG/4LBS	SWING TAG	2	0025997 658041	€ 39,07

ROUGHNECK

MINI SLEDGE HAMMER

Unique shape for outstanding versatility and performance.
Milled convex faces, 45° chamfered edges, overstrike protection
Solid fibreglass core, soft grip, drop forged, heat treated, painted head



CODE	DESCRIPTION	SIZE	LABEL	BOX	EAN-CODE	PRICE
65-622	MINI SLEDGE HAMMER	1.4KG/3LBS	SWING TAG	2	0 25997 656221	€ 32,19
65-624	MINI SLEDGE HAMMER	1.8KG/4LBS	SWING TAG	2	0 25997 656245	€ 35,56

BOLSTERS + BOLT CUTTERS

ROUGHNECK

BRICK BOLSTER WITH HAND GUARD

Overstrike protection, Soft grip, Polished tips
Tip protectors, drop forged, heat treated powder coated



CODE	DESCRIPTION	SIZE	LABEL	BOX	EAN-CODE	PRICE
31-986	BRICK BOLSTER WITH HAND GUARD	70X216MM/2¾X8½"	HANGING CARD	6	0025997 319867	€ 18,63

ROUGHNECK

BRICK BOLSTER WITH HAND GUARD

Overstrike protection, Soft grip, Polished tips
Tip protectors, drop forged, heat treated powder coated



CODE	DESCRIPTION	SIZE	LABEL	BOX	EAN-CODE	PRICE
31-992	BRICK BOLSTER WITH HAND GUARD 1	02X216MM/4X8½"	HANGING CARD	6	0025997 319928	€ 20,33

ROUGHNECK

ELECTRICIAN'S BOLSTER WITH HAND GUARD

Overstrike protection, Soft grip, Polished tips
Tip protectors, drop forged, heat treated powder coated



CODE	DESCRIPTION	SIZE	LABEL	BOX	EAN-CODE	PRICE
31-990	ELECTRICIAN'S BOLSTER WITH HAND GUARD	76X279MM/3X11"	HANGING CARD	6	0025997 319904	€ 19,83

ROUGHNECK

BOLSTER AND CHISEL SET - 3 PIECE

Ideal for building and maintenance applications. Overstrike protection, soft grip, polished tips, Tip protectors, drop forged, heat treated, powder coated



CODE	DESCRIPTION	LABEL	BOX	EAN-CODE	PRICE
31-970	BOLSTER AND CHISEL SET - 3 PIECE	HANGING BOX	2	5057902 319704	€ 46,22
1	BRICK BOLSTER WITH HAND GUARD - 70X216MM/2¾X8½"				
2	ELECTRICIAN'S BOLSTER WITH HAND GUARD - 76X254MM/3X10"				
3	COLD CHISEL WITH HAND GUARD - 25X254MM/1X10"				



ROUGHNECK

PROFESSIONAL BOLT CUTTERS

Ideal for cutting bolts, rods, wire, chains and padlocks. Easily adjustable jaws for quick re-alignment. Compound action increases leverage. Tubular steel handles offer strength while being lightweight. Large double injected soft grips for comfort. Chrome molybdenum steel jaws, Centre cut blades, Compound hinge, Lightweight, Tubular steel handles, Soft grip



CODE	DESCRIPTION	SIZE	LABEL	BOX	EAN-CODE	PRICE
39-114	PROFESSIONAL BOLT CUTTERS	350MM/14"	MAILER BOX	1	0025997391146	€ 38,37
39-118	PROFESSIONAL BOLT CUTTERS	450MM/18"	MAILER BOX	1	0025997391184	€ 48,37
39-124	PROFESSIONAL BOLT CUTTERS	600MM/24"	MAILER BOX	1	0025997391245	€ 65,05
39-130	PROFESSIONAL BOLT CUTTERS	750MM/30"	MAILER BOX	1	0025997391306	€ 90,07
39-136	PROFESSIONAL BOLT CUTTERS	900MM/36"	MAILER BOX	1	0025997391368	€ 115,11

CHISELS AND BOLSTERS

ROUGHNECK

COLD CHISELS

Roughneck Cold Chisels are manufactured from drop forged, heat treated steel for strength and durability. Powder coated with polished tips for greater corrosion resistance.

Polished tips, tip protectors, drop forged
Heat treated, powder coated



CODE	DESCRIPTION	SIZE	LABEL	BOX	EAN-CODE	PRICE
31-978	COLD CHISEL	16X152MM/5/8"	HANGING CARD	6	0025997319782	€ 7,10
31-979	COLD CHISEL	25X203MM/1X8"	HANGING CARD	6	0025997319799	€ 11,01
31-980	COLD CHISEL	25X254MM/1X10"	HANGING CARD	6	0025997319805	€ 12,70
31-981	COLD CHISEL	25X305MM/1X12"	HANGING CARD	6	0025997319812	€ 14,39
31-983	COLD CHISEL	25X457MM/1X18"	HANGING CARD	6	0025997319836	€ 20,33

ROUGHNECK

CONCRETE CHISEL WITH HAND GUARD

Fitted with a soft grip with hand guard for overstrike protection, Roughneck Concrete Chisels are manufactured from drop forged, heat treated steel for strength and durability. Powder coated with polished tips for greater corrosion resistance. 4mm pointed tip is ideal for breaking concrete slabs or making a hole in a variety of materials.

Overstrike protection, Soft grip, Polished tips, Tip protectors.
Drop forged, Heat treated, Powder coated, Size: 4x305mm/5/32x12"



CODE	DESCRIPTION	SIZE	LABEL	BOX	EAN-CODE	PRICE
31-998	CONCRETE CHISEL WITH HAND GUARD	4X305MM/5/32X12"	HANGING CARD	6	0025997319980	€ 19,37

ROUGHNECK

COLD CHISEL WITH HAND GUARD

Fitted with a soft grip with hand guard for overstrike protection, Roughneck Cold Chisels are manufactured from drop forged, heat treated steel for strength and durability. Powder coated with polished tips for greater corrosion resistance.

Overstrike protection, Soft grip, Polished tips, Tip protectors
Drop forged, Heat treated, Powder coated, Size: 25x457mm/1x18"



CODE	DESCRIPTION	SIZE	LABEL	BOX	EAN-CODE	PRICE
31-999	COLD CHISEL WITH HAND GUARD	25X457MM/1X18"	HANGING CARD	5	0025997319997	€ 25,35

PUNCH SETS

 **ROUGHNECK**

NAIL PUNCH SET - 3 PIECE

Chrome vanadium, Colour-coded grips
Contents: Nail punches: 0.8, 1.6, 2.5mm



CODE	DESCRIPTION	LABEL	BOX	EAN-CODE	PRICE
31-177	NAIL PUNCH SET - 3 PIECE	HANGING CARD	10	0025997 311779	€ 12,26

 **ROUGHNECK**

PARALLEL PIN PUNCH SET - 6 PIECE

Ideal for driving out rivets, bolts and pins.
Chrome vanadium, heat treated, polished tips
Contents: Parallel pin punches: 1.5, 3, 4, 5, 6, 8mm



CODE	DESCRIPTION	LABEL	BOX	EAN-CODE	PRICE
31-178	PARALLEL PIN PUNCH SET - 6 PIECE	HANGING BOX	6	0025997 311786	€ 21,94



 **ROUGHNECK**

ASSORTED PUNCH AND CHISEL SET - 12 PIECE

Ideal for engineering workshop, automotive and construction applications
Chrome vanadium, heat treated, polished tips
Centre punches: 2, 6, 8mm/Chisels: 10, 12, 16mm/parallel punches: 1.5, 3, 4, 5, 6, 8mm



CODE	DESCRIPTION	LABEL	BOX	EAN-CODE	PRICE
31-180	ASSORTED PUNCH & CHISEL SET - 12 PIECE	HANGING BOX	6	0025997 311809	€ 40,78



SPLITTING WEDGES + SPLITTING MAULS

ROUGHNECK

SPLITTING WEDGE

Splitting wedge. The quick, efficient way to split logs.
Extra large face, manganese steel, heat treated, anti pop-out, sharp tip



4 WAY SPILT



CODE	DESCRIPTION	SIZE	LABEL	BOX	EAN-CODE	PRICE
65-504/001	WOOD GRENADE® SPLITTING WEDGE	1.6KG/3.5LBS	WINDOW BOX	10	025997 655040	€ 28,49
65-504/002	WOOD GRENADE® SPLITTING WEDGE	1.6KG/3.5LBS	BULK PACKED	25	057902 655048	€ 28,49

ROUGHNECK

WOOD TWISTER

Dynamic twist and split action.
Twist and split action, anti pop-out, extra large face.
Drop forged, heat treated, powder coated

ROUGHNECK



CODE	DESCRIPTION	SIZE	LABEL	BOX	EAN-CODE	PRICE
65-510/001	WOOD TWISTER® SPLITTING WEDGE	2.3KG/5LBS	WINDOW BOX	1	5057902 655109	€ 25,41
65-510/002	WOOD TWISTER® SPLITTING WEDGE	2.3KG/5LBS	BULK PACKED	2	0025997 655101	€ 25,41

ROUGHNECK

SPLITTING WEDGE DISPLAY

4x Roughneck® Wood Twister
splitting wedge - 2.3kg/5lbs
8x Roughneck® Wood Grenade®
splitting wedge - 1.8kg/4lbs

CODE	DESCRIPTION	WIDTH	DEPTH	HEIGHT
SPLITWD	SPLITTING WEDGE DISPLAY	350MM	250MM	520MM

ROUGHNECK

SPLITTING MAUL

Compression fit handle, shock absorbing.
Grip, anti-jamming design, drop forged,
heat treated solid fibreglass core,
lanyard hole



CODE	DESCRIPTION	SIZE	LABEL	BOX	EAN-CODE	PRICE
65-666	SPLITTING MAUL	2.7KG/6LBS	SWING TAG	2	0025997 656665	€ 76,67
65-668	SPLITTING MAUL	3.6KG/8LBS	SWING TAG	2	0025997 656689	€ 88,32

ROUGHNECK

SPLITTING MAUL

Anti-jamming design.
Drop forged, heat treated,
painted head, polished cutting edge,
solid fibreglass core, soft grip



CODE	DESCRIPTION	SIZE	LABEL	BOX	EAN-CODE	PRICE
65-660	SPLITTING MAUL	2.7KG/6LBS	SWING TAG	2	0025997 656603	€ 69,47
65-662	SPLITTING MAUL	3.6KG/8LBS	SWING TAG	4	0025997 656627	€ 76,23

AXEFORD DISPLAY + FAST CUTTING SAWS

ROUGHNECK
GORILLA

FAST CUT PRUNING SAW + HOLSTER

Rubber handle, lanyard, hole,
PTFE low friction coating, triple, ground,
belt loop, impulse, hardened, holster



CODE	DESCRIPTION	SIZE	TEETH	LABEL	BOX	EAN-CODE	PRICE
66-800	FAST CUT PRUNING SAW	350MM/13¾"	6T	HANGING CARD	6	5057902 668000	€ 36,46
66-801	FAST CUT PRUNING SAW - REPLACEMENT BLADE	350MM/13¾"	6T	HANGING PACK	1	5057902 668017	€ 23,79

ROUGHNECK
GORILLA

FAST CUT FOLDING PRUNING SAW + SHEATH

With sheath, Triple ground, impulse hardened,
PTFE low friction coating, rubber handle,
safety lock, lanyard hole, sheath with belt loop



CODE	DESCRIPTION	SIZE	TEETH	LABEL	BOX	EAN-CODE	PRICE
66-805	FAST CUT FOLDING PRUNING SAW	180MM/7"	7T	HANGING CARD	6	5057902 668055	€ 41,77
66-806	FAST CUT FOLDING PRUNING SAW - REPLACEMENT BLADE	180MM/7"	7T	HANGING PACK	1	5057902 668062	€ 25,03

ROUGHNECK

AXES AND FORESTRY DISPLAY

2x Roughneck® Gorilla Splitting maul - 2.7kg/6lbs
1x Roughneck® Gorilla Splitting maul - 3.6kg/8lbs
2x Roughneck® Splitting maul - 2.7kg/6lbs
2x Roughneck® Splitting maul - 3.6kg/8lbs

2x Roughneck® Axe - 2.3kg/5lbs
2x Roughneck® Axe - 1.6kg/3½lbs
2x Roughneck® Axe - 0.6kg/1¼lbs
2x Roughneck® Kindling splitter - 1.1kg/2½lbs

3x Roughneck® Wood Grenade® Splitting wedge
3x Roughneck® Twister wood wedge
1x Roughneck® Fencing maul - 4.54kg/10lbs
1x Roughneck® Fencing maul - 6.35kg/14lbs

CODE	DESCRIPTION	WIDTH	DEPTH	HEIGHT
AXEFORD	AXES AND FORESTRY DISPLAY	1150MM	450MM	1300MM



LOPPERS

ROUGHNECK

XT PRO ANVIL LOPPERS

Drop forged for extra toughness, high leverage compound cutting action for a 45mm cutting capacity, max grip serrated anvil steadies material, chrome vanadium steel upper blade, heavy duty steel handles and air cushion grips.

Drop forged, High leverage compound action, 45mm cutting capacity, Max grip serrated anvil, Chrome vanadium steel blades, Heavy-duty steel handles, Air cushioned grips



CODE	DESCRIPTION	SIZE	WEIGHT	EAN-CODE	PRICE
66-865	XT PRO ANVIL LOPPERS	745MM/29¼"	14906	5057902668659	€ 71,44

LOPPERS

ROUGHNECK

XT PRO ANVIL LOPPERS - TELESCOPIC

Drop forged, high leverage compound cutting action for a 45mm cutting capacity, max grip serrated anvil steadies material, chrome vanadium steel upper blade, with telescopic heavy duty steel handles and air cushion grips.

Drop forged, High leverage compound action, 45mm cutting capacity, Max grip serrated anvil, Chrome vanadium steel blades, Heavy-duty steel handles, Quick adjust telescopic handles



CODE	DESCRIPTION	SIZE	WEIGHT	EAN-CODE	PRICE
66-866	XT PRO ANVIL LOPPERS - TELESCOPIC	695MM/27 1/2" - 945MM/37 1/4"	1830G	5057902668666	€ 81,16

ROUGHNECK

XT PRO BYPASS LOPPERS

Drop forged, with bypass blades, with a high leverage compound cutting action for a 40mm cutting capacity, with a hooked blade, with chrome vanadium steel blade, with heavy duty steel handles and air cushion grips.

Drop forged, High leverage compound action, 40mm cutting capacity, Hooked blade, Chrome vanadium steel blades, Heavy-duty steel handles, Air cushioned grips



CODE	DESCRIPTION	SIZE	WEIGHT	EAN-CODE	PRICE
66-867	XT PRO BYPASS LOPPERS	750MM/29 1/2"	1350G	5057902668666	€ 68,82

ROUGHNECK

XT PRO BYPASS LOPPERS - TELESCOPIC

Drop forged, with bypass blades, with a high leverage compound cutting action for 40mm cutting capacity, with hooked blade, with chrome vanadium steel blade, with telescopic heavy duty steel handles and air cushion grips.

Drop forged, High leverage compound action, 40mm cutting capacity, Hooked blade, Chrome vanadium steel blades, Heavy-duty steel handles, Quick adjust telescopic handles



CODE	DESCRIPTION	SIZE	WEIGHT	EAN-CODE	PRICE
66-868	XT PRO BYPASS LOPPERS - TELESCOPIC	695MM/27 1/4" - 945MM/37 1/4"	1740G	5057902668680	€ 78,60

HEDGE SHEARS + SHOVELS + FORKS

ROUGHNECK

XT PRO HEDGE SHEARS

Drop forged, with wavy edge blades, manufactured from Carbon steel, with heavy duty steel handles and air cushion grips. Drop forged, Wavy edge blades, Carbon steel blades, Heavy-duty steel handles, Air cushioned grips, Shock absorbing buffer



CODE	DESCRIPTION	SIZE	WEIGHT	EAN-CODE	PRICE
66-870	XT PRO HEDGE SHEARS	635MM/25"	1230G	5057902668703	€ 58,46

ROUGHNECK

XT PRO HEDGE SHEARS - TELESCOPIC

Drop forged, with wavy edge blades grip hedge branches, Carbon steel, with telescopic heavy duty steel handles and air cushion grips. Drop forged, Wavy edge blades, Carbon steel blades, Heavy-duty steel handles, Quick adjust telescopic handles, Air cushioned grips, Shock absorbing buffer



CODE	DESCRIPTION	SIZE	WEIGHT	EAN-CODE	PRICE
66-871	XT PRO HEDGE SHEARS TELESCOPIC	700MM/27 1/2" - 895MM/35 1/4"	1760G	5057902668710	€ 64,94

ROUGHNECK

MICRO FORK

Fit for loosening, lifting and turning soil in confined spaces, with a heavy-duty, heat treated tines and steel reinforced Power Ring socket, lightweight, fibreglass handle and full-size double-injected "D" grip handle. Full-size D-grip, Soft grip, Heavy-duty tines, Heat-treated, Tumble, lacquered finish, Tubular fibreglass handle, Power ring connection, Size: 150x740mm/6x29"



CODE	DESCRIPTION	SIZE	LABEL	BOX	EAN-CODE	PRICE
68-008	MICRO FORK	740MM/29"	FLAG	6	5057902680080	€ 27,08

ROUGHNECK

MINI SHOVEL - ROUND

For digging and shovelling in confined spaces, heavy-duty carbon steel blade and steel reinforced Power Ring socket, for shovelling material bulk bags, lightweight, fibreglass handle with full-size double-injected "D" grip handle. Full-size D-grip, Soft grip, Heavy-duty round blade, Foot treads, Heat-treated, Tumble, lacquered finish, Tubular fibreglass handle, Power ring connection, 150x880mm/6x34 1/2"



CODE	DESCRIPTION	SIZE	LABEL	BOX	EAN-CODE	PRICE
68-010	MINI SHOVEL - ROUND	880MM/34 1/2"	LABEL	6	5 057902 680103	€ 25,84

ROUGHNECK

LONG-HANDLED SHARP-EDGE SHOVEL

Fit for digging in compacted ground, slicing through roots and opening bulk bags or bags of cement, with a sharp serrated edge and ong fibreglass handle with contoured grip, ideal for deeper holes and trenches, manufactured from heavy duty, carbon steel with a corrosion resistant, tumble, lacquered finish with a power ring socket and with steel reinforced plug. Sharp serrated edge, Heavy-duty blade, Foot treads, Heat-treated, Tumble, lacquered finish, Tubular fibreglass handle, Power ring connection, Contoured grip



CODE	DESCRIPTION	SIZE	EAN-CODE	PRICE
68-044	LONG-HANDLED SHARP-EDGE SHOVEL	1460MM/57 1/2"	5 057902 680446	€ 30,56

ROUGHNECK

SHARP-EDGE SHOVEL

Ideal for digging in compacted ground, slicing through roots and opening bulk bags or bags of cement, with sharp serrated edge, manufactured from heavy duty, carbon steel with a corrosion resistant, tumble, lacquered finish, with power ring socket, with steel reinforced plug, with fibreglass handle, with a soft grip D-shape handle.

Sharp serrated edge, Heavy-duty blade, Foot treads, Heat-treated, Tumble, lacquered finish, Tubular fibreglass handle, Power ring connection, D-grip, Soft grip



CODE	DESCRIPTION	SIZE	EAN-CODE	PRICE
68-046	SHARP-EDGE SHOVEL	1070MM/42"	5057902680460	€ 27,08

SHOVELS & SPADES

ROUGHNECK

DIGGING FORK

NEW

Ideal for breaking up, aerating and turning over soil, spreading and removing debris, heat treated, heavy duty tines, with tumble, lacquered finish, with power ring socket, with steel reinforced plug, lightweight, fibreglass handle with a double-injected "D" grip handle. Heavy-duty tines, Heat-treated, Tumble, lacquered finish, Tubular fibreglass handle, Power ring connection, D-grip, Soft grip



CODE	DESCRIPTION	SIZE	EAN-CODE	PRICE
68-140	DIGGING FORK	1070MM/42"	5 057902 681405	€ 40,07

ROUGHNECK

LONG-HANDLED SHOVEL - SQUARE

NEW

For various gardening, landscaping and building applications, long fibreglass handle, contoured grip, heavy duty, carbon steel with a corrosion resistant, tumble, lacquered finish, with power ring socket, steel reinforced plug, with treads on the blade. Heavy-duty blade, Foot treads, Heat-treated, Tumble, lacquered finish, Tubular fibreglass handle, Power ring connection, Contoured grip.



CODE	DESCRIPTION	SIZE	EAN-CODE	PRICE
68-144	LONG-HANDLED SHOVEL - SQUARE	1460MM/57 1/2"	5 057902 681443	€ 30,56

ROUGHNECK

SHOVEL - SQUARE

NEW

General-purpose shovel for moving sand, gravel, cement, earth and for shovelling out and filling trenches, lightweight, fully hardened pressed steel construction, with fibreglass handle and double-injected "D" grip, with power ring socket and steel reinforced plug, treads on the blade. Heavy-duty blade, Deep scoop, Foot treads, Heat-treated, Tumble, lacquered finish Tubular fibreglass handle, Power ring connection, D-grip, Soft grip.



CODE	DESCRIPTION	SIZE	LABEL	BOX	EAN-CODE	PRICE
68-146	SHOVEL - SQUARE	1070MM/42"	LABEL	6	5 057902 681469	€ 32,85

ROUGHNECK

GRAIN SHOVEL

NEW

Ideal for moving various bulk materials, lightweight, with corrosion resistant aluminium head and fibreglass handle, with a deep scoop, with lift blade. Lightweight aluminium head, Reinforcing ribs, Corrosion-resistant, Deep scoop, High lift blade, Tubular fibreglass handle, Power ring connection, D-grip, Soft grip.



CODE	DESCRIPTION	SIZE	LABEL	BOX	EAN-CODE	PRICE
68-191	GRAIN SHOVEL	1070MM/42"	-	-	5 057902 681917	€ 54,95

ROUGHNECK

LONG HANDLED TRENCHING SHOVEL

NEW

The Roughneck Long Handled Trenching Shovel with its heavy duty tapered blade is ideal for digging deep and narrow trenches. The long fibreglass handle with contoured grip, offers increased leverage and power, allowing for a more comfortable, upright position to be maintained whilst digging. Manufactured from heavy duty, carbon steel with a corrosion resistant, tumble, lacquered finish.

Tapered blade, Heavy-duty blade, Foot treads, Heat-treated, Tumble, lacquered finish, Tubular fibreglass handle, Contoured grip.



CODE	DESCRIPTION	SIZE	LABEL	BOX	EAN-CODE	PRICE
68-214	LONG HANDLED TRENCHING SHOVEL	1460MM/57 1/2"	LABEL	6	5 057902 682145	€ 41,90

ROUGHNECK

LONG-HANDLED DIGGING SPADE

NEW

The Roughneck Digging Spade is ideal for various gardening, landscaping and building applications. The long fibreglass handle with contoured grip, offers increased leverage and power, allowing for a more comfortable, upright position to be maintained whilst digging. Built to last, manufactured from heavy duty, carbon steel with a corrosion resistant, tumble, lacquered finish. The Power Ring socket, with steel reinforced plug, provides stronger blade to handle connection. Features treads on the blade allowing increased pressure to be applied with reduced risk of slippage. Heavy-duty blade, Foot treads, Heat-treated, Tumble, lacquered finish, Tubular fibreglass handle, Power ring connection, Contoured grip.



CODE	DESCRIPTION	SIZE	EAN-CODE	PRICE
68-223	LONG-HANDLED DIGGING SPADE	1460MM/57 1/2"	5 057902 682235	€ 30,56

SHOVELS & SPADES + LAWN EDGING IRON

ROUGHNECK

LONG-HANDLED SHARP-EDGE DRAINAGE SHOVEL



With sharpened blade, for digging deep narrow trenches and digging holes. Long fibreglass handle with contoured grip, offers increased leverage and power. From heavy duty, carbon steel with a corrosion resistant, tumble, lacquered finish. The Power Ring socket, with steel reinforced plug, stronger blade. Features treads on the blade allowing increased pressure to be applied with reduced risk of slippage. Sharpened blade, Heavy-duty blade, Foot treads, Heat-treated, Tumble, lacquered finish, Tubular fibreglass handle, Power ring connection, Contoured grip.



ROUGHNECK

SHARP-EDGE DRAINAGE SHOVEL



With sharpened blade, for digging deep narrow trenches and digging holes for posts and signs. Built to last, from heavy duty, carbon steel with a corrosion resistant, tumble, lacquered finish. The Power Ring socket, with steel reinforced plug, stronger blade to handle connection. Lightweight, fibreglass handle with a double-injected "D" grip handle. Features treads on the blade allowing increased pressure to be applied with reduced risk of slippage. Sharpened blade, Heavy-duty blade, Foot treads, Heat-treated, Tumble, lacquered finish, Tubular fibreglass handle, Power ring connection, D-grip, Soft grip.



CODE	DESCRIPTION	SIZE	EAN-CODE	PRICE
68-237	LONG-HANDLED SHARP-EDGE DRAINAGE SHOVEL	1460MM/57 1/2"	5 057902 682372	€ 32,75



CODE	DESCRIPTION	SIZE	LABEL	BOX	EAN-CODE	PRICE
68-238	SHARP-EDGE DRAINAGE SHOVEL	1070MM/42"	LABEL	6	5 057902 682372	€ 32,75

ROUGHNECK

SHARP-EDGE LAWN EDGING IRON

Built to last, manufactured from heavy duty, carbon steel with a corrosion resistant tumble lacquer finish, connected to a tough and durable fibreglass handle. With sharp serrated blade. The large foot treads ensure maximum comfort whilst applying force by foot.

Sharp Serrated Edge, Heavy Duty Blade, Foot Treads, Heat Treated, Tumble, Lacquered Finish, Tubular Fibreglass Handle, D-Grip, Soft Grip.



CODE	DESCRIPTION	SIZE	LABEL	BOX	EAN-CODE	PRICE
68-311	SHARP-EDGE LAWN EDGING IRON	210X1000MM/81 4/8X39 1/2"	-	-	5057902683119	€ 36,75

LAWN EDGING IRON

ROUGHNECK

POST HOLE DIGGER - DUAL-PIVOT

For digging extra deep and narrow holes. Offset tubular steel handles, soft grip, dual-pivot action, hardened steel blades



CODE	DESCRIPTION	SIZE	LABEL	BOX	EAN-CODE	PRICE
68-265	POST HOLE DIGGER - DUAL-PIVOT	1.5M/59"	LABEL	1	0025997 682657	€ 129,12



FENCING MAUL + MICRO SHOVEL

ROUGHNECK

FENCING MAUL

For driving in wooden fence posts.
Cast iron head, compression fit handle,
solid fibreglass core, shock absorbing grid, lanyard hole



CODE	DESCRIPTION	SIZE	LABEL	BOX	EAN-CODE	PRICE
64-760	FENCING MAUL	4.54KG/10LBS	LABEL	4	0025997 647601	€ 108,55



ROUGHNECK

MICRO SHOVEL

Perfect for digging and shovelling in confined spaces.
Soft grip, full size d-grip, tubular fibreglass handle,
power ring connection, foot tread, heavy duty blade,
heat treated



CODE	DESCRIPTION	SIZE	LABEL	BOX	EAN-CODE	PRICE
68-004	MICRO SHOVEL - ROUND	150X700MM/6X27½"	LABEL	6	0025997680042	€ 25,22
68-006	MICRO SHOVEL - SQUARE	150X700MM/6X27½"	LABEL	6	0025997680066	€ 25,22



ROUGHNECK

MICRO SHOVEL DISPLAY

x5 Roughneck® Micro shovel - round
x5 Roughneck® Micro shovel - square



CODE	DESCRIPTION	WIDTH	DEPTH	HEIGHT
MICROSD	MICRO SHOVEL DISPLAY	440MM	550MM	960MM

LANDSCAPING AND CONTRACTOR TOOLS

THE BIG MUTT PRO

MULTI-PURPOSE DEMOLITION SCRAPER - FIBREGLOSS

Ideal for cutting, chopping, digging, edging, scraping, trenching and more.
Forged steel blade, resharpenable polished tip, heat treated, powder coated



CODE	DESCRIPTION	SIZE	LABEL	BOX	EAN-CODE	PRICE
88-040	MULTI-PURPOSE DEMOLITION SCRAPER - FIBREGLOSS	175MM/7"	LABEL	6	5057902 880402	€ 63,16



LANDSCAPING AND CONTRACTOR TOOLS



MULTI-PURPOSE DEMOLITION SCRAPER - FIBREGLASS

Ideal for cutting, chopping, digging, edging, scraping, trenching and more.
Forged steel blade, resharpenable, polished tip, heat treated, powder coated,
D-grip, solid fibreglass core



CODE	DESCRIPTION	SIZE	LABEL	BOX	EAN-CODE	PRICE
88-030	MULTI-PURPOSE DEMOLITION SCRAPER - FIBREGLASS	100MM/4"	LABEL	6	5057902 880303	€ 48,81



MULTI-PURPOSE DEMOLITION SCRAPER - STEEL

Ideal for cutting, chopping, digging, edging, scraping, trenching and more.
Forged steel blade, resharpenable, polished tip, heat treated, powder coated
D-grip, tubular steel handle



CODE	DESCRIPTION	SIZE	LABEL	BOX	EAN-CODE	PRICE
64-397	MULTI-PURPOSE DEMOLITION SCRAPER - STEEL	100MM/4"	LABEL	6	0025997 643979	€ 66,15



MULTI-PURPOSE DEMOLITION SCRAPER - WOOD

Ideal for cutting, chopping, digging, edging, scraping, trenching and more.
Forged steel blade, resharpenable, polished tip, heat treated, powder coated
D-grip, wooden handle



CODE	DESCRIPTION	SIZE	LABEL	BOX	EAN-CODE	PRICE
64-393	MULTI-PURPOSE DEMOLITION SCRAPER - WOOD	100MM/4"	LABEL	6	0025997 643931	€ 52,32



MUTTS DISPLAY

3x Roughneck® Big Mutt Pro - steel
6x Roughneck® Big Mutt - wood



CODE	DESCRIPTION	WIDTH	DEPTH	HEIGHT
MUTTSD	MUTTS DISPLAY	600MM	600MM	870MM

ROUGHNECK

HEAVY DUTY IMPACT SCRAPER

Ideal for removing tiles, flooring, plaster and adhesive.
No hammer required, sliding handle, hammer and chisel action, heavy duty, comfort grip.



CODE	DESCRIPTION	SIZE	LABEL	BOX	EAN-CODE	PRICE
52-250	HEAVY DUTY IMPACT SCRAPER	100MM/4"	HANGING BOX	12	0025997 522502	€ 46,97
52-260	SCRAPER BLADES - 2 PAC	100MM/4	HANGING BOX	1	0025997 522601	€ 16,43



ROUGHNECK

FLOOR SCRAPER

Ideal for removing paint, plaster, grease, dirt and stubborn residues from hard surfaces.
Stainless steel blade, tubular fibreglass handle, soft grip.



CODE	DESCRIPTION	SIZE	LENGTH	LABEL	BOX	EAN-CODE	PRICE
64-390	FLOOR SCRAPER	204MM/8"	1.5M/59 1/4"	SLEEVE	12	0025997 643900	€ 33,37
64-391	FLOOR SCRAPER	305MM/12"	1.5M/59 1/4"	SLEEVE	6	0025997 643917	€ 36,07
64-394	FLOOR SCRAPER BLADE	204MM/8"	-	HANGING PACK	6	0025997 643948	€ 10,28
64-395	FLOOR SCRAPER BLADE	305MM/12"	-	HANGING PACK	6	0025997 643955	€ 12,63

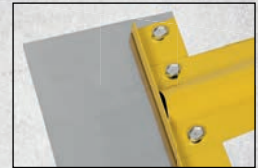

ROUGHNECK

CONTRACTOR'S TAMPERS - SQUARE

Ideal for compacting asphalt, shingle, soft earth or sand.
Cast iron head, solid fibreglass core, soft grip



CODE	DESCRIPTION	SIZE	LABEL	BOX	EAN-CODE	PRICE
64-379	CONTRACTOR'S TAMPER - SQUARE	200X200MM/8X8"	LABEL	1	0025997 643795	€ 75,10
64-381	CONTRACTOR'S TAMPER - SQUARE	250X250MM/10X10"	LABEL	1	0025997 643818	€ 92,13



ROUGHNECK

CONTRACTOR'S TAMPER - RECTANGULAR

Ideal for compacting asphalt, shingle, soft earth or sand.
Cast iron head, solid fibreglass core, soft grip



CODE	DESCRIPTION	SIZE	LABEL	BOX	EAN-CODE	PRICE
64-375	CONTRACTOR'S TAMPER - RECTANGULAR	100X250MM/4X10"	LABEL	1	0025997 643757	€ 72,10



BUILDING TOOLS



ROUGHNECK®

ULTIMATE MORTAR GUN

FOR USE WITH MORTAR, GROUT, ADHESIVE, SEALANT, CARTRIDGES, FOIL PACKS AND BULK MATERIAL



THRUST
RATIO 16:1

ALUMINIUM
BARREL 1L



MORTAR
NOZZLE
(LARGE)



MORTAR
NOZZLE
(SMALL)



MORTAR
NOZZLE
(STRAIGHT)



MORTAR
NOZZLE
(ANGLED)



STANDARD
NOZZLE X2



FOIL PACK
ADAPTOR



MORTAR
PLUNGERS X2



STANDARD
PLUNGERS X2
MORTAR



SPANNER



CODE	DESCRIPTION	SIZE	LABEL	BOX	EAN-CODE	PRICE
32-150	ULTIMATE MORTAR GUN	380MM	HANGING BOX	12	0025997 321501	€ 49,97



SEALANT AND ADHESIVE GUN

For use with adhesive and sealant, in standard diameter cartridges and foil packs

- 1 Sealant and adhesive gun
- 2 Nozzles x2
- 3 Plungers x2
- Thrust ratio 10:1, Aluminium barrel 1l



CODE	DESCRIPTION	SIZE	LABEL	BOX	EAN-CODE	PRICE
32-102	SEALANT AND ADHESIVE GUN	380MM	HANGING BOX	12	0025997 321020	€ 34,40



ULTIMATE MORTAR GUN ACCESSORY KIT - 12 PIECES

For use with adhesive and sealant, in standard diameter cartridges and foil packs

- 1 Sealant and adhesive gun
- 2 Nozzles x2
- 3 Plungers x2
- Thrust ratio 10:1, Aluminium barrel 1l

1



2



3



CODE	DESCRIPTION	LABEL	BOX	EAN-CODE	PRICE
32-152	ULTIMATE MORTAR GUN ACCESSORY KIT - 12 PIECE	HANGING BOX	1	0025997 321525	€ 13,34



MORTAR AND GROUT GUN

For use with bulk mortar and grout.
Aluminium barrel 1l, thrust ratio 10:1



CODE	DESCRIPTION	SIZE	LABEL	BOX	EAN-CODE	PRICE
32-100B	MORTAR AND GROUT GUN	380MM	WINDOW BOX	12	0025997 321006	€ 36,40



MORTAR
SCOOP
NOZZLE
(STRAIGHT)

MORTAR
NOZZLE
(ANGLED)

GROUT
NOZZLE

SCOOP

PLUNGERS
X2

BUILDING TOOLS

ROUGHNECK

NON-DRIP HEAVY DUTY ADHESIVE GUN

NEW

For use with instant grab adhesives and silicon sealants. The non drip feature is ideal for working indoors or at height, to avoid spillage.

For cartridges up to 400ml. Heavy duty ratchet mechanism, thrust ratio 18:1, Non-drip, rotating barrel, quick release, hook end.



CODE	DESCRIPTION	SIZE	LABEL	BOX	EAN-CODE	PRICE
12-020	NON-DRIP HEAVY DUTY ADHESIVE GUN	280MM/11"	FLAG	12	5057902120201	€ 29,84

ROUGHNECK

VARI-FLOW HEAVY DUTY ADHESIVE GUN

NEW

For use with exceptional power and minimum force. The non-drip selector is ideal when working indoors, or at height, to avoid spillage. The rotating barrel and comfortable rounded grip ensure maximum control and reduce fatigue. Quick release mechanism and hook end for easy cartridge change.



For cartridges up to 400ml. Variable thrust ratio 12:1/25:1, non-drip selector rotating barrel, quick release, hook end.



CODE	DESCRIPTION	SIZE	LABEL	BOX	EAN-CODE	PRICE
12-030	VARI-FLOW HEAVY DUTY ADHESIVE GUN	280MM/11"	FLAG	12	5057902120300	€ 40,91



ROUGHNECK

SKELETON SEALANT GUNS

NEW

The Roughneck Skeleton Sealant Gun is a lightweight gun delivering a 7:1 thrust ratio. It features a quick release trigger and hook end for easy cartridge changes and a built-in nozzle cleaner.

Thrust ratio 7:1, Lightweight, Quick release, Hook end, Nozzle cleaner.

32-200 - For cartridges up to 310ml
32-210 - For cartridges up to 400ml



CODE	DESCRIPTION	SIZE	LABEL	BOX	EAN-CODE	PRICE
32-200	SKELETON SEALANT GUNS	230MM/9"	FLAG	12	0025997322003	€ 7,12
32-210	SKELETON SEALANT GUNS	280MM/11"	FLAG	12	0025997322102	€ 8,93

ROUGHNECK

HEAVY DUTY SEALANT GUN

NEW

The Roughneck Heavy Duty Sealant Gun has substantial 13:1 thrust ratio and convenient non-drip feature making it ideal for working indoors or at height. With rotating barrel, ergonomic grip, hook-end and quick release trigger, built-in nozzle cleaner.

For cartridges up to 400ml.

Thrust ratio 13:1, Non-drip, Rotating barrel, Heavy duty, Quick release, Hook end, Nozzle cleaner



CODE	DESCRIPTION	SIZE	LABEL	BOX	EAN-CODE	PRICE
32-230	HEAVY DUTY SEALANT GUN	265MM/10 1/2"	FLAG	12	0025997322300	€ 17,94

BUILDING TOOLS

DIGGERS
tools

DIG811 TRADE FOAM GUN

€ 18,40

- 2 Plastic nozzles
- 2 Plastic extension tubes
- Metal housing
- Dosing screw
- Ptfe can holder and needle
- Iron with polishing and nickel plating
- Ergonomic grip

EAN: 5425009852811



DIGGERS
tools

DIG828 FOAM GUN WITH PTFE COATING

€ 28,60

- 2 Plastic nozzles
- 2 Plastic extension tubes
- Easy to clean
- Dosing screw
- Ergonomic grip

EAN: 5425009852828



WORKSHOP / TOOLS



SQUARES



DESCRIPTION

The Patented Metric Speed® Square 25 cm Square is five tools in one! It's a Try Square, Miter Square, Protractor, Line Scriber and a Saw Guide. This square has indications for the One-Number MethodSM of rafter layout and includes an English instruction book. It also features two separate scales, so you can work in either metric or degrees for common and hip valley rafter layouts. Just like the Speed® Square, it's made of high-grade aluminium alloy.

EU202

€ 30,50

25 CM

Two metric and degree scales for common and hip-valley rafters

High-grade aluminium alloy construction

Traditional One-Number MethodSM for rafter layout

0.5 cm Speed® notches facilitate scribing lines

Matte finish to prevent glare

Made in the U.S.A.

EAN: 038987002021



S0101

€ 21,75

25 CM

Speed square, 7"

EAN: 038987001017

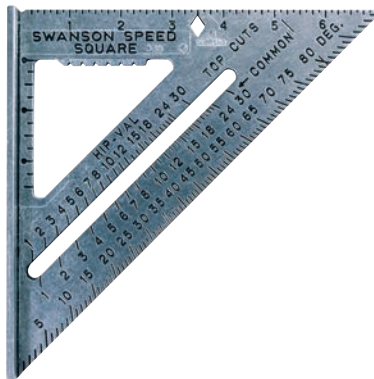

S0107

€ 42,18

Swanson Tool S0107 The Big 12 Speed Square with Layout Bar 12 inch x 12 inch

EAN: 038987001079

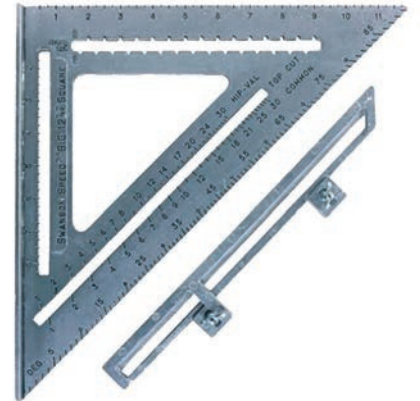

T0101

€ 20,25

30 inch

The Speed® Square Plain Gradations

5 TOOLS IN ONE!

1 Try Square, 2 Miter Square, 3 Saw Guide,

4 Line Scriber, 5 Protractor

EAN: 038987001024



T0108

€ 35,50

30 inch

The Big 12® Speed® Square

The Big 12® is seven tools in one: a framing square, try square, miter square, protractor, saw guide, stair gauge and out-of-square corner angle finder.

EAN: 038987001086

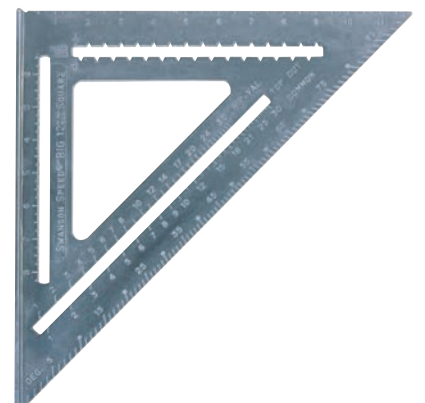

LEVELS

TLM MAGNETIC TORPEDO LEVELS



TLO43M € 33,96

9 inch - 22,86 cm

EAN: 038987600432

TLO49M € 50,43

9 inch - 22,86 cm

EAN 038987000492



SVT TORPEDO LEVELS



SVT200 € 122,88

9 inch - 22,86 cm

EAN 038987932007

SVT011 € 51,25

6 inch - 28 cm

EAN 038987930119



SVE STRAIGHT EDGES



SVE121 € 36,64

121,92 cm non marring straight edge

EAN: 038987951213

SVE183 € 52,27

182,88 cm non marring straight edge

EAN: 038987951831

SVE244 € 68,97

243,84 cm non marring straight edge

EAN: 038987952449



AE140 € 8,84

100cm meter stick

EAN: 038987001390



LLP002

€ 5,71

Line Level – 2 pk

EAN 038987110023



PL001M

€ 8,60

Magnetic Post Level Magnetic

EAN 038987110016



TAPE MEASURE

SVGL8: **GRIPLINE™** MAGNETIC 8 M

For accurate measurements on PVC, Conduit, and Pipe up to 2-inches in diameter use a SAVAGE® GripLine™ tape. The tape measure features large numbers, 1-1/16-inch wide blade, and an exclusive magnetic tip. The large numbers are displayed on top and bottom for increased user readability. The magnetic tip can be used to attach to a metal surface such as a metal beam or window frame. The tape measure can clip onto a carpenter, contractor or plumber's tool belt and is compact enough to easily fit into a tool box.

Available Models:

SVGL8

€ 27,18



SAVAGE™
by SWANSON



SVPS8: **PROSCRIBE™** MAGNETIC 8 M

The SAVAGE™ ProScribe™ quickly transfers radius or straight lines. Edge allows for no sliver straight line scribing. Grips metal surfaces with magnetic tip. Ideal for contractors and builders. Easy to use blade lock hold tape in place. Nylon sleeve protective coating.

Features:

- Scribes circles into surfaces with centring pin
- Scribe guide eliminates slivers
- 1 in. wide blade with large number display on top and bottom for easy readability
- Magnetic Tip
- 8 ft. Standout

Available Models:

SVPS8

€ 24,33



LEVELS

CP700

€ 4,72

Carpenter Pencils -5 pieces

EAN 023898700700

SWANSON

SWANSON

SG0020

€ 9,05

Solid brass stair gauges - 2 pieces

EAN 038987000201



SVCM233

€ 22,65

30,48 cm combination square

EAN: 038987942334



TS152M

€ 24,08

20 cm Try Square with Hardwood Handle

EAN: 03898700072



TS20157M

€ 19,90

40 x 61 cm Steel Carpenter Square

EAN: 038987201578



SVK666

€ 37,44

Folding Saw with 3pc

EAN: 038987906664



CPL BLK

€ 3,29

AlwaysSharp® Replacement 24Tips

EAN 038987004049



CPL RED

€ 3,29

AlwaysSharp® Replacement 24 RED Tips

EAN 038987004445



CP216

€ 5,31

Refillable Carpenter Pencils

EAN 038987002168



HAMMERS

VAUGHAN®

10538: FIBERGLASS RIP HAMMER € 52,61

20 oz Milled Face Fiberglass Rip Hammer,
16" Handle. 567 gram

EAN: 51218105384



VAUGHAN®

10508: FIBERGLASS RIP HAMMER € 44,55

22 oz Milled Face Solid Steel Rip Hammer, 16" Handle Polished head,
624 gram

EAN: 51218105087



VAUGHAN®

10120: STEEL RIP HAMMER € 60,99

22 oz Milled Face Solid Steel Rip Hammer, 16" Handle Polished head,
sides and claw. 624 gram

EAN: 51218101201



VAUGHAN®

12715: SOLID STEEL NAIL HAMMER € 49,80

20 oz Solid Steel Nail Hammer. 567 gram

EAN: 51218127157



VAUGHAN®

10815: STEEL NAIL HAMMER € 53,68

24 oz Solid Steel Nail Hammer. 680 gram

EAN: 51218108156



VAUGHAN®

10910: SOLID STEEL NAIL HAMMER € 45,44

16 oz Solid Steel nail Hammer. 454 gram

EAN: 51218109108



VAUGHAN®

11505: FIBERGLASS NAIL HAMMER € 44,55

FS20: 20 oz Fiberglass Nail Hammer Polished striking head, sides
and claw. 567 gram

EAN: 51218115055



VAUGHAN®

11410: FIBERGLASS NAIL HAMMER € 41,18

16 oz Fiberglass Nail Hammer Polished striking head, sides and claw.
454 gram

EAN: 51218114102



HAMMERS

VAUGHAN®

13030: MILLED FACE SOLID STEEL € 78,85

19 oz Milled Face Solid Steel With 16" Handle. 539 gram

EAN:51218130300



VAUGHAN®

13220: MILLED FACE RIP HAMMER € 47,53

Stealth 170Z Solid Steel, Milled Face Rip Hammer. 482 gram

EAN: 51218132205



VAUGHAN®

17901 : SOLID STEEL PROSPECTING PICK € 48,70

AP22: 22 oz Solid Steel Prospecting Pick. 624 gram

EAN: 51218179019



VAUGHAN®

18412 : SOLID STEEL BRICKLAYER'S HAMMER € 54,94

18 woz Solid Steel Bricklayer's Hammer. 510 gram

EAN: 51218184129

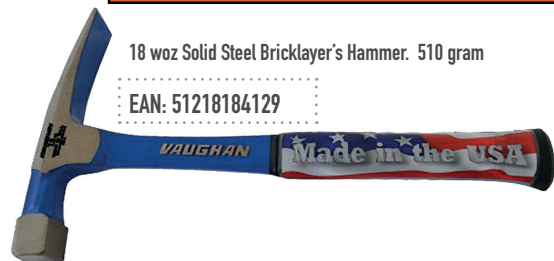

VAUGHAN®

15530 : BALL PEIN HAMMER € 23,05

Commercial 16 oz Ball Pein Hammer. Polished face, bevel, sides, and pein. 454 gram

EAN: 51218155303



VAUGHAN®

10300: FRAMING HAMMER € 47,26

23 oz Milled Face California Framing Hammer. 652 gram

EAN: 51218103007



VAUGHAN®

15730 : BALL PEIN HAMMER € 28,11

Commercial 24 oz Ball Pein Hammer. 680 gram

EAN: 51218157307



VAUGHAN®

11600: MILLED FACE CALIFORNIA FRAMER € 41,96

19 oz Milled Face California Framer. 539 gram

EAN: 51218116007



SUPERBARS

VAUGHAN®

45001: VAUGHAN 15" SUPERBAR € 19,69

Super Bar 15" is an essential tool for homeowners and tradesmen. 38,1 cm

EAN: 51218000054



VAUGHAN®

45201: 21" SUPERBAR € 23,10

21" superbar. B215L Superbar 21" is an essential tool for homeowners and tradesmen. 53,34 cm

EAN: 51218452013



VAUGHAN®

45101: 12" STUBBY BAR € 24,85

B215S Stubby Bar 12" is an essential tool for homeowners and tradesmen. 30,5 cm

EAN: 51218451016



VAUGHAN®

46004: 5-1/2" MINI BAR € 6,10

222: 5-1/2" Mini Bar. 12,7cm

EAN: 51218460049



VAUGHAN®

57027: 10-1/2" BEAR CLAW NAIL PULLER € 23,11

10-1/2" Bear Claw Nail Puller. 25,4 cm

EAN: 51218570274



VAUGHAN®

57030: 11-3/4" BEAR CLAW NAIL PULLER € 27,77

11-3/4" Bear Claw Nail Puller. 28 cm

EAN: 51218570304



VAUGHAN®

57043: 10" BEAR CLAW, SCRAPER BAR € 24,34

BC/SB10: 10" Bear claw, scraper bar. 25,40 cm

EAN: 51218570434



VAUGHAN®

33502: SOLID STEEL CAMP AXE € 63,32

Solid Steel Camp Axe, 18" Handle. 45,72 cm

EAN: 51218335026



VAUGHAN®

33402: 1/4 SOLID STEEL CAMP AXE € 56,82

1/4 Solid Steel Camp Axe With Sheath. r reproductive harm.

EAN: 51218334029



BOARD CARRIERS - LIFTER

ROUGHNECK
GORILLA

GORILLA GRIPPER - ADVANTAGE

The safer, easier way to carry thin sheet material and heavy bags. Comfort grip, one-person, operation, one-handed operation, safer handling, lightweight



CODE	DESCRIPTION	MAX. LOAD	MAX. CAPACITY	LABEL	BOX	EAN-CODE	PRICE
32-630	GORILLA GRIPPER - ADVANTAGE	45KG/100LB	S 0-19MM/0-3/4"	SLEEVE	1	0025997 326308	€ 78,24

ROUGHNECK
GORILLA

GORILLA GRIPPER - CONTRACTOR

The safer, easier way to carry medium thick sheet material. Safer handling, one-person operation, one-handed operation heavy duty, comfort grip



CODE	DESCRIPTION	MAX. LOAD	MAX. CAPACITY	LABEL	BOX	EAN-CODE	PRICE
32-610	GORILLA GRIPPER - CONTRACTOR	90KG/200LBS	10-28MM/3/8-1 1/8"	SLEEVE	1	0025997 326100	€ 120,89

ROUGHNECK

PANEL AND BOARD CARRIER

Ideal for lifting plasterboard and wood panels. Comfort grip



CODE	DESCRIPTION	MAX. LOAD	LABEL	BOX	EAN-CODE	PRICE
32-025	PANEL AND BOARD CARRIER	80KG/176LBS	LABEL	6	0025997 320252	€ 15,60

ROUGHNECK

DOOR AND BOARD LIFTER

Lift, swivel and position with one foot. Non slip pads x3



CODE	DESCRIPTION	MAX. LOAD	LIFT HEIGHT	LABEL	BOX	EAN-CODE	PRICE
32-500B	DOOR AND BOARD LIFTER	75KG/165LBS	65MM/2 1/2"	HANGING BOX	1	0 025997 325004	€ 42,37

WIRE BRUSHES

ROUGHNECK

ULTRA SLIM WIRE BRUSH SET - 3 PIECE

Steel, brass and nylon bristles for varied applications.

- 1 Ultra slim brush - 3 row stainless steel
- 2 Ultra slim brush - 3 row brass
- 3 Ultra slim brush - 3 row nylon

Soft grip, 3 row.



CODE	DESCRIPTION	LABEL	BOX	EAN-CODE	PRICE
52-005	ULTRA SLIM WIRE BRUSH SET - 3 PIECE	HANGING	12	0 025997 520058	€ 9,31

ROUGHNECK

NARROW WIRE BRUSH SET - 3 PIECE

Steel, brass and nylon bristles for varied applications.

- 1 Narrow wire brush - 3 row nylon
- 2 Narrow wire brush - 3 row brass
- 3 Narrow wire brush - 3 row stainless steel

Soft grip, 3 row.



CODE	DESCRIPTION	LABEL	BOX	EAN-CODE	PRICE
52-010	NARROW WIRE BRUSH SET - 3 PIECE	HANGING BOX	10	0025997 520102	€ 12,70

ROUGHNECK

WIDE WIRE BRUSH SET - 3 PIECE

Steel, brass and nylon bristles for varied applications.

- 1 Wide wire brush - 3 row nylon
- 2 Wide wire brush - 3 row brass
- 3 Wide wire brush - 3 row stainless steel

Soft grip, Scraper, • 5 row



CODE	DESCRIPTION	LABEL	BOX	EAN-CODE	PRICE
52-012	WIDE WIRE BRUSH SET - 3 PIECE	HANGING BOX	6	0025997 520126	€ 16,85

ROUGHNECK

HEAVY DUTY WIRE BRUSH WITH SCRAPER - 4 ROW

For general purpose use.
Steel scraper, 4 row, soft grip



CODE	DESCRIPTION	TYPE	LABEL	BOX	EAN-CODE	PRICE
52-042	HEAVY DUTY WIRE BRUSH WITH SCRAPER	4 ROW CARBON STEEL	HANGING PACK	6	0025997 520423	€ 8,38

ROUGHNECK

HEAVY DUTY WIRE BRUSHE WITH SCRAPER - 3 ROW

Steel, brass and nylon bristles for varied applications.
Steel scraper, 3 row, soft grip



CODE	DESCRIPTION	TYPE	APPLICATION	LABEL	BOX	EAN-CODE	PRICE
52-030	HEAVY DUTY WIRE BRUSH WITH SCRAPER	3 ROW CARBON STEEL	GENERAL PURPOSE	HANGING PACK	6	0025997 520300	€ 7,63
52-032	HEAVY DUTY WIRE BRUSH WITH SCRAPER	3 ROW STAINLESS STEEL	REDUCED CONTAMINATION	HANGING PACK	6	0 025997 520324	€ 9,31
52-034	HEAVY DUTY WIRE BRUSH WITH SCRAPER	3 ROW BRASS SOFTER	SURFACES	HANGING PACK	6	0 025997 520348	€ 11,01

WIRE BRUSHES + SCRAPER

ROUGHNECK

HEAVY DUTY WIRE BRUSH - 4 ROW

For general purpose use.
4 row, soft grip



CODE	DESCRIPTION	TYPE	LABEL	BOX	EAN-CODE	PRICE
52-040	HEAVY DUTY WIRE BRUSH	4 ROW CARBON STEEL	HANGING PACK	6	0025997 520409	€ 8,38

ROUGHNECK

HEAVY DUTY SHOE HANDLE WIRE BRUSH

Contoured handle for extra comfort
4 row, soft grip



CODE	DESCRIPTION	TYPE	LABEL	BOX	EAN-CODE	PRICE
52-044	HEAVY DUTY SHOE HANDLE WIRE BRUSH	4 ROW CARBON STEEL	HANGING PACK	9	0 025997 520447	€ 8,38

ROUGHNECK

HEAVY DUTY TAPERED BLOCK WIRE BRUSH

Ideal for cleaning corners
5 row, soft grip



CODE	DESCRIPTION	TYPE	LABEL	BOX	EAN-CODE	PRICE
52-050	HEAVY DUTY TAPERED BLOCK WIRE BRUSH	5 ROW CARBON STEEL	HANGING PACK	6	0025997 520508	€ 10,08

ROUGHNECK

HEAVY DUTY TWO HANDED WIRE BRUSH

Ideal for applying extra force
5 row, soft grip



CODE	DESCRIPTION	TYPE	LABEL	BOX	EAN-CODE	PRICE
52-052	HEAVY DUTY TWO HANDED WIRE BRUSH	5 ROW CARBON STEEL	HANGING PACK	6	0025997 520522	€ 16,85

ROUGHNECK

HEAVY DUTY WIRE SCRUB BRUSH

Ideal for applying extra force
6 row, soft grip,
suitable for use with #52-080



CODE	DESCRIPTION	TYPE	LABEL	BOX	EAN-CODE	PRICE
52-060	HEAVY DUTY WIRE SCRUB BRUSH	6 ROW CARBON STEEL	HANGING PACK	8	0025997 520607	€ 11,01

ROUGHNECK

PAVING AND PATIO WIRE BRUSH WITH SCRAPER

Ideal for cleaning paving joints.
Pointed scraper, 3 row,
suitable for use with #52-080



CODE	DESCRIPTION	TYPE	LABEL	BOX	EAN-CODE	PRICE
52-070	PAVING AND PATIO WIRE BRUSH WITH SCRAPER	3 ROW CARBON STEEL	HANGING PACK	8	0025997 520706	€ 11,01

ROUGHNECK

STEEL HANDLE

Lightweight, Comfort grip, Hanging hole, Suitable for use with #52-060 and #52-070 or similar



CODE	DESCRIPTION	HANDLE Ø	HANDLE LENGTH	LABEL	BOX	EAN-CODE	PRICE
52-080	STEEL HANDLE	25MM/1"	1.3M/51¼"	LABEL	12	0025997 520805	€ 7,63



MEASURING TAPES + CHALK LINE SET

ROUGHNECK

OPEN FRAME MEASURING TAPES

Impact resistant case, 3:1 gear ratio, blade guard double sided blade (metric/imperial), 15mm wide fibreglass blade loop and folding hook, handle drive release



CODE	DESCRIPTION	SIZE	ACCURACY	LABEL	BOX	EAN-CODE	PRICE
43-320	OPEN FRAME FIBREGLASS TAPE	30M/100'	EU CLASS II	SLEEVE	4	5057902433202	€ 32,87
43-325	OPEN FRAME FIBREGLASS TAPE	50M/165'	EU CLASS II	SLEEVE	4	5057902433257	€ 47,93



ROUGHNECK

RAPID REWIND CHALK LINE SET

Ideal for use on plasterboard, brick, concrete and wood
Impact resistant case, 6:1 gear ratio, 15kg line strength, foldaway handle, quick fill 8oz blue chalk



CODE	DESCRIPTION	SIZE	LABEL	BOX	EAN-CODE	PRICE
43-070	RAPID REWIND CHALK LINE SET	30M/100'	WINDOW BOX	6	5057902 430706	€ 18,21

BEVEL EDGE CHISELS



BEVEL EDGE CHISELS

Chrome vanadium, heat treated, striking cap, thru-tang, soft grip, tip protectors



CODE	DESCRIPTION	SIZE	LABEL	BOX	EAN-CODE	PRICE
30-106	BEVEL EDGE CHISEL	6MM/¼"	HANGING CARD	6	0 025997 301060	€ 14,58
30-110	BEVEL EDGE CHISEL	10MM/¾"	HANGING CARD	6	0 025997 301107	€ 14,81
30-113	BEVEL EDGE CHISEL	13MM/½"	HANGING CARD	6	0 025997 301138	€ 15,06
30-116	BEVEL EDGE CHISEL	16MM/¾"	HANGING CARD	6	0 025997 301169	€ 15,22
30-119	BEVEL EDGE CHISEL	19MM/¾"	HANGING CARD	6	0 025997 301190	€ 15,47
30-125	BEVEL EDGE CHISEL	25MM/1"	HANGING CARD	6	0 025997 301251	€ 17,10
30-132	BEVEL EDGE CHISEL	32MM/1¼"	HANGING CARD	6	0 025997 301329	€ 19,54
30-138	BEVEL EDGE CHISEL	38MM/1½"	HANGING CARD	6	0 025997 301381	€ 21,98
30-150	BEVEL EDGE CHISEL	50MM/2"	HANGING CARD	6	0 025997 301503	€ 24,42

PRO SERIES



BEVEL EDGE CHISELS SET - 3 PIECES

Chrome vanadium, heat treated, striking cap, thru-tang, soft grip, tip protectors

- 1 Bevel edge chisel - 25mm/1"
- 2 Bevel edge chisel - 19mm/¾"
- 3 Bevel edge chisel - 13mm/½"



CODE	DESCRIPTION	LABEL	BOX	EAN-CODE	PRICE
30-153	BEVEL EDGE CHISELS SET - 3 PIECES	WINDOW BOX	4	0025997 301534	€ 45,53

PRO SERIES



BEVEL EDGE CHISELS SET - 4 PIECES

Chrome vanadium, heat treated, striking cap, thru-tang, soft grip, tip protectors

- 1 Bevel edge chisel - 25mm/1"
- 2 Bevel edge chisel - 19mm/¾"
- 3 Bevel edge chisel - 13mm/½"
- 4 Bevel edge chisel - 6mm/¼"



CODE	DESCRIPTION	LABEL	BOX	EAN-CODE	PRICE
30-154	BEVEL EDGE CHISELS SET - 4 PIECES	WINDOW BOX	6	0025997 301541	€ 50,92

PRO SERIES



BEVEL EDGE CHISELS

ROUGHNECK

BEVEL EDGE CHISELS SET - 5 PIECES

Chrome vanadium, heat treated, striking cap, thru-tang, soft grip, tip protectors
With canvas wallet

- 1 Bevel edge chisel - 32mm/1 1/2"
- 2 Bevel edge chisel - 25mm/1"
- 3 Bevel edge chisel - 19mm/3/4"
- 4 Bevel edge chisel - 13mm/1/2"
- 5 Bevel edge chisel - 6mm/1/4"



CODE	DESCRIPTION	LABEL	BOX	EAN-CODE	PRICE
30-175	BEVEL EDGE CHISELS SET - 5 PIECES	SLEEVE	6	0025997 301756	€ 83,81

PRO SERIES

ROUGHNECK

BEVEL EDGE CHISELS AND SHARPENING KIT - 6 PIECES

Chrome vanadium, heat treated, striking cap, thru-tang, soft grip, tip protectors
With plastic storage case

- 1 Honing oil
- 2 Honing guide
- 3 Dual grit oil stone (120/140)
- 4 Chisel sizes: 13mm/1/2", 19mm/3/4" and 25mm/1"



CODE	DESCRIPTION	LABEL	BOX	EAN-CODE	PRICE
30-165	BEVEL EDGE CHISELS AND SHARPENING KIT - 6 PIECES	STORAGE CASE	6	0025997 30165	€ 67,04

PRO SERIES

ROUGHNECK

CHISELS SHARPENING KIT - 3 PIECES

- 1 Dual grit stone (120/240)
- 2 Honing guide
- 3 Honing oil



CODE	DESCRIPTION	LABEL	BOX	EAN-CODE	PRICE
30-190	CHISELS SHARPENING KIT - 3 PIECES	HANGING BOX	6	0025997 301909	€ 22,71

ROUGHNECK

CARPENTER'S PENCILS - PACK 10

With universal sharpener.
Unsharpened both ends,
oval/hexagonal design

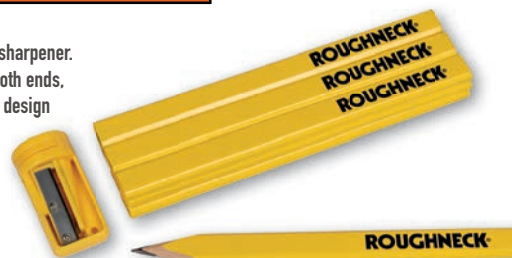

THIS PRODUCT IS MADE OF FSC CERTIFIED TIMBER



www.fsc.org
FSC® C109654
The mark of responsible forestry



CODE	DESCRIPTION	SIZE	LABEL	BOX	EAN-CODE	PRICE
44-110	CARPENTER'S PENCILS - 10 PACK	175MM/7"	WINDOW BOX	12	5057902 441108	€ 9,07

CLAMPS

ROUGHNECK

ONE-HANDED SPEED CLAMPS

Turboclamp
Quick release, 600nm clamping force, soft jaw pads, one-handed operation



CODE	DESCRIPTION	SIZE	CLAMPING FORCE	LABEL	BOX	EAN-CODE	PRICE
38-010	ONE-HANDED SPEED CLAMP	150X75MM/6X3"	600NM	FLAG	10	0025997 38010	€ 16,29

ROUGHNECK

HEAVY DUTY SPRING CLAMPS

Super strong spring, pivoting jaws, soft grip



CODE	DESCRIPTION	SIZE	LABEL	BOX	EAN-CODE	PRICE
38-331	HEAVY DUTY SPRING CLAMP	25MM/1"	SWING TAG	8	0025997 383318	€ 3,59
38-332	HEAVY DUTY SPRING CLAMP	50MM/2"	SWING TAG	8	0025997 383325	€ 6,32
38-333	HEAVY DUTY SPRING CLAMP	75MM/3"	SWING TAG	8	0 25997 383332	€ 8,66

ROUGHNECK

HEAVY DUTY METAL SPRING CLAMPS

Heavy duty, super strong spring, soft jaw pads, comfort grip



CODE	DESCRIPTION	SIZE	LABEL	BOX	EAN-CODE	PRICE
38-351	HEAVY DUTY METAL SPRING CLAMP	25MM/1"	SWING TAG	8	0025997 383516	€ 3,59
38-352	HEAVY DUTY METAL SPRING CLAMP	50MM/2"	SWING TAG	8	0025997 383523	€ 6,58
38-353	HEAVY DUTY METAL SPRING CLAMP	75MM/3"	SWING TAG	8	0025997 383530	€ 10,65

ROUGHNECK

V-FORCE QUICK RELEASE HAND CLAMPS

Heavy duty, super strong spring, soft jaw pads, comfort grip



CODE	DESCRIPTION	SIZE	LABEL	BOX	EAN-CODE	PRICE
38-345	V-FORCE QUICK RELEASE HAND CLAMP	50MM/2"	SWING TAG	8	0025997 383455	€ 7,51
38-347	V-FORCE QUICK RELEASE HAND CLAMP	80MM/3"	SWING TAG	8	0025997 383479	€ 11,28

CLAMPS + FLOORING TOOLS

ROUGHNECK

LAMINATE FLOORING CUTTER

V-support stand, clean cut blade, guillotine action, sturdy frame and handle, support bar for 90° cuts, padded feet



CODE	DESCRIPTION	MAX. CUT THICKNESS	MAX. CUT WIDTH	LABEL	BOX	EAN-CODE	PRICE
36-010	LAMINATE FLOORING CUTTER	11MM/ 1/2"	200MM/8"	MAILER BOX	1	0025997 360104	€ 86,74

FLOORING TOOLS & MULTI-TOOL

 **ROUGHNECK**

LAMINATE AND WOOD FLOORING SPACERS - PACK OF 48

Ideal for ensuring a consistent expansion gap around skirting board.
Interlocking design

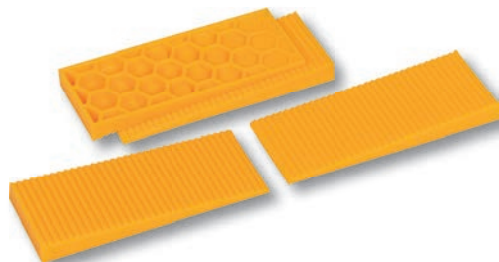

CODE	DESCRIPTION	SIZE	LABEL	BOX	EAN-CODE	PRICE
36-040	LAMINATE AND WOOD FLOORING SPACERS - PACK OF 48	78X30X2-8MM	HANGING BOX	6	0025997 360401	€ 9,95

 **ROUGHNECK**

FLOORING KNOCKING BLOCK

Ideal for laminate and wooden flooring.
Heavy duty, nylon



CODE	DESCRIPTION	LABEL	BOX	EAN-CODE	PRICE
36-050	FLOORING KNOCKING BLOCK	LABEL	12	0025997 360500	€ 24,02

 **ROUGHNECK**

HEAVY DUTY PULL BAR

Ideal for laminate and real wood flooring.
Welded head, nylon striking face,
prying function, felt lined,
powder coated



CODE	DESCRIPTION	LABEL	BOX	EAN-CODE	PRICE
64-450	HEAVY DUTY PULL BAR	BAR LABEL	4	0025997 644501	€ 25,72

 **ROUGHNECK**

MULTI-TOOL WITH LED LIGHT - 13 FUNCTIONS

With canvas pouch.
Functions include:
Pliers with wire cutter, led torch, nail file, saw,
slotted screwdriver x4, knife x2, bottle opener,
phillips screwdriver, can opener, stainless steel handles,
13-functions



CODE	DESCRIPTION	LABEL	BOX	EAN-CODE	PRICE
88-054	MULTI-TOOL WITH LED LIGHT - 13 FUNCTIONS	HANGING BOX	6	5057902 880549	€ 56,50

 **ROUGHNECK**

MULTI-TOOL WITH LED LIGHT - 9 FUNCTIONS

With canvas pouch
Functions include:
Knife, bottle opener, saw, can opener, spanner,
Crv screwdriver bit - slotted, Crv screwdriver bit - ph1,
Crv screwdriver bit - ph2, led torch, aluminium handles
9-function



CODE	DESCRIPTION	LABEL	BOX	EAN-CODE	PRICE
88-050	MULTI-TOOL WITH LED LIGHT - 9 FUNCTIONS	HANGING BOX	6	5057902 880501	€ 28,71

PADLOCKS

Stronghold®

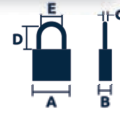

Solid Steel - Open Shackle

Code	LPCB	CEN	Security Rating	@	Description	Dimensions mm					Barcode	Key Blank	Pack Type	Min Qty	MK
						A	B	C	D	E					
SS65S		CEN 5	10	@WORK	65mm Open shackle steel lock 6 pin S cylinder	65	31.8	12.7	29	29.5	5012245003994	CYKEY/S1/BL	BLISTER	2	■
SS50S	LEVEL 2	CEN 4	9	@WORK	50mm Open shackle steel lock 6 pin S cylinder	50	26	10	26	22	5012245003420	CYKEY/S1/BL	BLISTER	3	■
SS50P5		CEN 3	8	@WORK	50mm Open shackle steel lock P5 (5 pin) cylinder	50	26	10	26	22	5012245007756	KB P5	BLISTER	3	■



SS65S LEVEL 2



SS50S



SS50P5

SS65S € 163,59

SS50S € 78,17

SS50P5 € 72,90

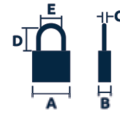

Solid Steel - Closed Shackle

Code	LPCB	CEN	Security Rating	@	Description	Dimensions mm					Barcode	Key Blank	Pack Type	Min Qty	MK
						A	B	C	D	E					
SS65CS		CEN 6	10	@WORK	65mm Closed shackle steel lock 6 pin S cylinder	65	31.8	12.7	19	19	5012245003918	CYKEY/S1/BL	BLISTER	2	■
SS50CS	LEVEL2	CEN 4	9	@WORK	50mm Closed shackle steel lock 6 pin S cylinder	50	26	10	16	16	5012245003413	CYKEY/S1/BL	BLISTER	3	■
SS50CP5		CEN 3	8	@WORK	50mm Closed shackle steel lock P5 (5 pin) cylinder	50	26	10	16	16	5012245007763	KB P5	BLISTER	3	■

Solid Steel - Long Shackle

SS65S/2.5		CEN 5	10	@WORK	65mm 2.5" Long shackle steel lock 6 pin S cylinder	65	31.8	12.7	65	29.5	Special	CYKEY/S1/BL	BOX	1	■
SS50P5/2.5		CEN 3	8	@WORK	50mm 2.5" Long shackle steel lock P5 (5 pin) cylinder	50	26	10	65	22	5012245009996	KB P5	BOX	3	■

New SS45S - Open Shackle

SS45S			7	@WORK	45mm Open shackle steel lock 6 pin S cylinder	49.1	32.1	6	35.5	20	5012245008494	CYKEY/S1/BL	BOX	1	■
-------	--	--	---	-------	---	------	------	---	------	----	---------------	-------------	-----	---	---



SS65CS



SS50CS



SS50CP5



SS65S/2.5



SS50P5/2.5



SS45

SS65CS € 206,49

SS65S/2.5 € 163,59

SS50CS € 98,01

SS50P5/2.5 € 72,90

SS50CP5 € 76,21

SS45 € 71,50

PADLOCKS

Stronghold® SS50 Combi Extra High Security Padlocks



Code	Security Rating	@	Description	Dimensions mm					Barcode	Number of Combinations	Pack Type	Min Qty
				A	B	C	D	E				
SS50/COMBI	8	@WORK	5 Wheel O/S Combi Hardened steel c/w weather cover	55	30	10	24	22	5012245028690	100,000	BLISTER	2
SS50C/COMBI	8	@WORK	5 Wheel C/S Combi Hardened steel c/w weather cover	55	30	10	14	16	5012245028706	100,000	BLISTER	2



SS50/COMBI



SS50CS/COMBI

SS50/COMBI € 111,96

SS50C/COMBI € 137,78

Warrior® Combi Range

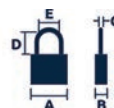

Open Shackle

Code	Security Rating	@	Description	Dimensions mm					Barcode	Number of Combinations	Pack Type	Min Qty
				A	B	C	D	E				
WARRIOR COMBI 65	8	@WORK	5 Wheel 65mm Open shackle Combination padlock	65	39	12	30	28	5012245035797	100,000	BLISTER	4
WARRIOR COMBI 55	7	@WORK	4 Wheel 55mm Open shackle Combination padlock	55	32	10	25	23	5012245035827	10,000	BLISTER	6
WARRIOR COMBI 45	6	@WORK	4 Wheel 45mm Open shackle Combination padlock	45	25	8	20	18	5012245035858	10,000	BLISTER	6

Closed Shackle

WARRIOR COMBI 65C	9	@WORK	5 Wheel 65mm Closed shackle Combination padlock	65	39	12	25	23	5012245035780	100,000	BLISTER	4
WARRIOR COMBI 55C	8	@WORK	4 Wheel 55mm Closed shackle Combination padlock	55	32	10	19	19	5012245035810	10,000	BLISTER	4
WARRIOR COMBI 45C	7	@WORK	4 Wheel 45mm Closed shackle Combination padlock	45	25	8	15	15	5012245035841	10,000	BLISTER	6

Long Shackle

WARRIOR COMBI 65/2.5	8	@WORK	5 Wheel 65mm 2.5" Long shackle Combination padlock	65	39	12	63	28	5012245035803	100,000	BLISTER	4
WARRIOR COMBI 55/2.5	7	@WORK	4 Wheel 55mm 2.5" Long shackle Combination padlock	55	32	10	63	23	5012245035834	10,000	BLISTER	6
WARRIOR COMBI 45/2.5	6	@WORK	4 Wheel 45mm 2.5" Long shackle Combination padlock	45	25	8	63	18	5012245035865	10,000	BLISTER	6



WAR COMBI 45 WAR COMBI 45C

WAR COMBI 45 € 48,83

WAR COMBI 45/2.5 € 51,13

WAR COMBI 45CS € 56,16

WAR COMBI 55 WAR COMBI 55C

WAR COMBI 55 € 59,12

WAR COMBI 55/2.5 € 60,59

WAR COMBI 55CS € 70,04

WAR COMBI 55 WAR COMBI 55C

WAR COMBI 65 € 70,04

WAR COMBI 65/2.5 € 79,49

WAR COMBI 65CS € 80,82

Warrior® Key Range



Open Shackle

Code	CEN	Security Rating	@	Description	Dimensions mm					Barcode	Key Blank	Pack Type	Min Qty	Price Ex VAT
					A	B	C	D	E					
WARRIOR 65	CEN 3	8	@WORK	65mm Open shackle steel padlock 5 pin cylinder	65	34	12	30	24	5012245035704	KB P5	BLISTER	4	£46.74
WARRIOR 55	CEN 3	7	@WORK	55mm Open shackle steel padlock 5 pin cylinder	55	34	10	30	24	5012245035735	KB P5	BLISTER	6	£36.85
WARRIOR 45	CEN 2	6	@WORK	45mm Open shackle steel padlock 5 pin cylinder	45	26	8	20	20	5012245035766	KB P5	BLISTER	6	£30.56

Closed Shackle

WARRIOR 65C	CEN 3	9	@WORK	65mm Closed shackle steel padlock 5 pin cylinder	65	34	12	27	16	5012245035698	KB P5	BLISTER	4	£51.23
WARRIOR 55C	CEN 3	8	@WORK	55mm Closed shackle steel padlock 5 pin cylinder	55	34	10	17	15	5012245035728	KB P5	BLISTER	6	£41.35
WARRIOR 45C	CEN 2	7	@WORK	45mm Closed shackle steel padlock 5 pin cylinder	45	26	8	18	15	5012245035759	KB P5	BLISTER	6	£35.05

Long Shackle

WARRIOR 65/2.5	CEN 3	8	@WORK	65mm 2.5" Long shackle steel padlock 5 pin cylinder	65	34	12	63	24	5012245035711	KB P5	BLISTER	4	£50.23
WARRIOR 55/2.5	CEN 3	7	@WORK	55mm 2.5" Long shackle steel padlock 5 pin cylinder	55	34	10	63	24	5012245035742	KB P5	BLISTER	6	£40.44
WARRIOR 45/2.5	CEN 2	6	@WORK	45mm 2.5" Long shackle steel padlock 5 pin cylinder	45	26	8	63	20	5012245035773	KB P5	BLISTER	6	£34.15



WARRIOR 65



WARRIOR 55



WARRIOR 45

WARRIOR 65 € 74,99

WARRIOR 55 € 59,12

WARRIOR 45 € 48,83

WARRIOR 65CS € 81,97

WARRIOR 55CS € 66,27

WARRIOR 45CS € 56,16



WARRIOR 65CS



WARRIOR 55CS



WARRIOR 45CS



WARRIOR 65/2.5



WARRIOR 55/2.5



WARRIOR 45/2.5

WARRIOR 65/2.5 € 79,49

WARRIOR 55/2.5 € 68,68

WARRIOR 45/2.5 € 60,59

PADLOCKS

Warehouse Lock Range



Code	Security Rating	@	Description	Dimensions mm					Barcode	Key Blank	Pack Type	Min Qty
				A	B	C	D	E				
ASWL1	6	@WORK	60mm Armoured Brass Block Lock (Small) 5 pin	60	25	10	12	22	5012245004250	KB P5	BLISTER	6
ASWL2	7	@WORK	80mm Armoured Brass Block Lock (Large) 5 pin	80	30	11	15	29	5012245004267	KB P5	BLISTER	6



ASWL1



ASWL 2

ASWL 1 € 62,44

ASWL 2 € 84,41

DCL Range



Code	Security Rating	@	Description	Dimensions mm					Barcode	Key Blank	Pack Type	Min Qty
				A	B	C	D	E				
DCL1	6	@WORK	70mm Disc style padlock 5 pin	70	27.5	9.5	17.5	17	5012245003666	KB P5	BLISTER	6
DCL1KA	6	@WORK	KA Disc style padlock 5 pin	70	27.5	9.5	17.5	17	Special	KB P5	BOX	1



DCL 1 € 32,79

DCL 1 KA1 € 35,23

Combi-Bolt5

Patented combination locking bolt

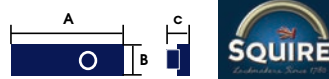

Code	Security Rating	@	Description	Dimensions mm			Barcode	Number of Combinations	Pack Type	Min Qty
				A	B	C				
COMBI4	4	@HOME	120mm Combination Bolt blue die cast recodable	120	50	40	5012245009002	10,000	BLISTER	4
COMBI4 CH	4	@HOME	120mm Chrome finish Combination Bolt recodable	120	50	40	5012245020182	10,000	BLISTER	4
COMBI3	3	@HOME	92mm Combination Bolt blue die cast recodable	92	35	33	5012245031034	1,000	BLISTER	4
COMBI3 CH	3	@HOME	92mm Chrome finish Combination Bolt recodable	92	35	33	5012245031041	1,000	BLISTER	4



COMBI4



COMBI3

COMBI4 € 25,81

COMBI4CH € 32,09

COMBI3 € 24,42

COMBI3CH € 28,60



COMBI4 CH



COMBI3 CH



TC CHAIN **G CHAIN** **J CHAIN** **SS65CS/TC14** **SS50COMBI/G3** **SS50/G3** **DCL1/J3**
High Security Hardened Alloy Steel Chains - Sold Secure Approved

Code	Security Rating	Sold Secure	Description	Dimensions mm		Barcode	Pack Type	Min Qty
				Link Diameter	Chain Length			
TC14/3	10	Motorcycle	TC Chain alloy steel hardened chain, black sleeve	14	915	5012245028089	BOX	1
TC14/4	10	Motorcycle	TC Chain alloy steel hardened chain, black sleeve	14	1200	5012245028096	BOX	1
G3	9	Bicycle	G Chain alloy steel hardened chain, black sleeve	10	915	5012245006537	BOX	1
G4	9	Bicycle	G Chain alloy steel hardened chain, black sleeve	10	1200	5012245003116	BOX	1
J3	8	Bicycle	J Chain alloy steel hardened chain, black sleeve	8	915	5012245008630	BOX	1
J4	8	Bicycle	J Chain alloy steel hardened chain, black sleeve	8	1200	5012245004366	BOX	1

TC14/3 € 143,71

G3 € 60,69

J3 € 39,41

TC14/4 € 179,98

G4 € 74,99

J4 € 50,05



Key Safes

Code	Sold Secure	@	Description	Dimensions mm			Barcode	Number of Combinations	Pack Type	Min Qty
				A	B	C				
KEYKEEP1		@WORK	Combination Key Safe Blistered	85	120	35	5012245022087	10,000	BLISTER	2

Keykeep 1™
4 Wheel Combination Key Safe



Product features

- Durable construction
- Four wheel recodable combination lock
- Weather resistant cover
- Easy to fit and recode

Important Note: All key safes and key keeps should be placed out of sight so as not to invite attack. Fix your key safe in a discrete location and only make its location known to those who need access.

Check with your insurer that using a key safe does not in any way conflict with the terms and conditions of your insurance policy.

KEYKEEP1 € 40,11

PADLOCKS



CP Range Padlocks

CP60 - 60mm

Code	Security Rating	@	Description	Dimensions mm					Barcode	Number of Combinations	Pack Type	Min Qty
				A	B	C	D	E				
CP60	6	@HOME	60mm Combi Padlock - 5 wheel	60	33	10	34	28	5012245025736	100,000	BLISTER	3
CP60/2.5	6	@HOME	CP60 with a 63mm vertical shackle clearance	60	33	10	63	28	5012245025743	100,000	BLISTER	3
CP60CS	7	@HOME	CP60 with closed shackle	60	33	10	29	22	5012245025750	100,000	BLISTER	3

CP50 - 50mm

CP50	5	@HOME	50mm Combi Padlock - 4 wheel	50	26	8	26	22.6	5012245021783	10,000	BLISTER	6
CP50/1.5	5	@HOME	CP50 with a 38mm vertical shackle clearance	50	26	8	38.1	22.6	5012245021806	10,000	BLISTER	6
CP50/2.5	5	@HOME	CP50 with a 63mm vertical shackle clearance	50	26	8	63.5	22.6	5012245021813	10,000	BLISTER	6
CP50CS	6	@HOME	CP50 with closed shackle	50	26	8	22	16	5012245021790	10,000	BLISTER	3

CP40 - 40mm

CP40	4	@HOME	40mm Combi Padlock - 4 wheel	40	22	6	20	17	5012245024609	10,000	BLISTER	6
CP40/2.5	4	@HOME	CP40 with a 63mm vertical shackle clearance	40	22	6	63	17	5012245024616	10,000	BLISTER	6
CP40CS	4	@HOME	CP40 with closed shackle	40	22	6	17	13	5012245024623	10,000	BLISTER	6

CP30 - 30mm

CP30	2	@LEISURE	30mm Combi Padlock - 3 wheel	30	16	4	15	13	5012245033649	1,000	BLISTER	6
------	---	----------	------------------------------	----	----	---	----	----	---------------	-------	---------	---



CP60

CP60CS

CP60/2.5

CP 60 € 49,88

CP 60CS € 51,90

CP 60/2.5 € 55,81

CP 50 € 38,37

CP 50CS € 55,81

CP 50/1.5 € 41,51

CP 50/2.5 € 48,48



CP50

CP50CS

CP50/1.5

CP 50/2.5



CP60

CP60CS

CP60/2.5

CP 40 € 20,06

CP 40CS € 25,81

CP 40/2.5 € 23,02

CP 30 € 19,53



CP30

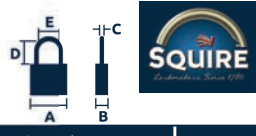

Lion Range - Premium Solid Brass

Code	Security Rating	@	Description	Dimensions mm					Barcode	Key Blank	Pack Type	Min Qty
				A	B	C	D	E				
LN2	2	@LEISURE	25mm Premium Brass 4 pin	24.5	11.1	4	16.7	13.5	5012245002676	KB LN A SL	BLISTER	12
LN3	2	@LEISURE	30mm Premium Brass 4 pin Double Locking	31.5	13	5.5	19.5	16.5	5012245002683	KB LN C SL	BLISTER	12
LN4	3	@HOME	40mm Premium Brass 5 pin Double Locking	39.5	14	6	21.1	22.5	5012245002690	KB LN C SL	BLISTER	6
LN5	4	@HOME	50mm Premium Brass 5 pin Double Locking	51	15.5	8.8	30	28	5012245002713	KB LN C SL	BLISTER	6
LN60	5	@HOME	60mm Premium Brass 5 pin Double Locking	60	18.6	9.5	35.5	33.5	5012245003376	KB LN C SL	BLISTER	6
LN4/2.5	3	@HOME	2.5" L/S 40mm Premium Brass 5 pin Double Locking	39.5	14	6	64	22.5	5012245002706	KB LN C SL	BLISTER	6
LN5/2.5	4	@HOME	2.5" L/S 50mm Premium Brass 5 pin Double Locking	51	15.5	8.8	65	28	5012245006032	KB LN C SL	BLISTER	6



LN2	€ 11,86
LN3	€ 14,30
LN4	€ 16,57
LN4/2.5	€ 18,66
LN5	€ 22,67
LN5/2.5	€ 23,79
LN60	€ 28,60



LADDERS DIY

DOUBLE SIDED ALUMINIUM STEPS

Two-sided aluminium stepladders EN 131. Maximum 150 kg. Sturdy rails with a dimension of 40x20 mm provide safety. Special caps for the rails which protect against slipping. 80 mm wide steps with non-slip ribbing provide comfortable and safe use.

DD	-2	-3	-4	-5	-6	-7	-8
Numbers of degrees	2	3	4	5	6	7	8
Height of the ladder, m	0,395	0,605	0,815	1,04	1,24	1,5	1,675
Working height, m	1,7	1,9	2,1	2,3	2,5	2,8	3,0
Ladder length, m	0,415	0,65	0,9	1,115	1,34	1,6	1,8
Ladder width, m	0,39	0,41	0,43	0,45	0,48	0,51	0,52
Platform, mm	160 x 340	160 x 340	160 x 340	160 x 340	160 x 340	160 x 340	160 x 340
Step width, mm	80	80	80	80	80	80	80
Profile, mm	40x20	40x20	40x20	40x20	40x20	40x20	40x20
Load capacity of 125kg weight, kg	1	2	2,9	3,3	4,6	6,9	7,5
load capacity of 150 kg	1,8	2,5	3,1	4,2	7,1	7,5	8

Certificate EN 131
Max loading weight is 150KG

DIGGERS
tools

DD22: 2X2 STEPS € 42,42

Professional aluminium double sided step ladder, maximum allowable load -150 kg . 2x2 steps

EAN 5425009851128



DIGGERS
tools

DD23: 2X3 STEPS € 64,00

Professional aluminium double sided step ladder, maximum allowable load -150 kg . 2x3 steps

EAN 5904680000228



DIGGERS
tools

DD24: 2X4 STEPS € 82,63

Professional aluminium double sided step ladder, maximum allowable load -150 kg . 2x4 steps

EAN5904680010401



DIGGERS
tools

DD25: 2X5 STEPS € 100,41

Professional aluminium double sided step ladder, maximum allowable load -150 kg . 2x5 steps

EAN 5904680010500



DIGGERS
tools

DD26: 2X6 € 122,05

Professional aluminium double sided step ladder, maximum allowable load -150 kg . 2x5steps

EAN 5904680010609



DIGGERS
tools

DD27: 2X7 STEPS € 146,14

Professional aluminium double sided step ladder, maximum allowable load -150 kg . 2x6 steps

EAN 5904680010708



DIGGERS
tools

DD28: 2X8 STEPS € 167,41

Professional aluminium double sided step ladder, maximum allowable load -150 kg . 2x7 steps

EAN 5904680010807



SINGLE TELESCOPIC LADDERS

DIGGERS
tools

DIGTL26

€ 140,76

Length: 2.6M
Folding size: 46*7*74 cm
Steps: 9
NO stabilizer
Aluminium: 1.3mm-1.5mm
Max load: 150KG - 6,8KG

EAN 5425009853320



SOFT CLOSING



DIGGERS
tools

DIGTL32

€ 177,48

Length: 3.2M
Folding size: 47*7*80 cm
Steps 11
A stabilizer
Aluminium: 1.3mm-1.5mm
Max load: 150KG - 8KG

EAN 5425009853337



SOFT CLOSING



DIGGERS
tools

DIGTL38

€ 216,00

Length: 3.8M
Folding size: 48*8*86 cm
Steps 13
A stabilizer
Aluminium: 1.3mm-1.5mm
Max load: 150KG - 10KG

EAN 5425009853344



SOFT CLOSING

BROADFIX SEAL-TUBES



SEAL-A-TUBE UPRIGHT DISPLAY TOWER AND REFILL/COUNTER TOP BOX

The Upright Tower is perfect to stand next to your Silicones or Adhesives in store. The Tower can also be attached to any racking or shelving. The Refill/Counter Top Box is perfect for any Trade Counter.

SEAL-A-TUBE (THIN) € 2,69

Seal-A-Tube will stop any tube of silicone or adhesive from drying out.

Thin Bead (Blue)

Creates an air tight seal so no more dried out tubes

Perfect for Trade and DIY



SEAL-A-TUBE (THICK) € 2,69

Seal-A-Tube will stop any tube of silicone or adhesive from drying out.

Thick Bead (Yellow)

Creates an air tight seal so no more dried out tubes

Perfect for Trade and DIY



BST60 : UPRIGHT DISPLAY € 161,28

Seal A-Tube upright display 30 x Thin bead (blue), 30 x Thick bead (yellow)

EAN: 5060172011636



BST50B: COUNTERTOP DISPLAY € 134,40

Countertop display, blue, 50 pieces

EAN: 5060172011650



BST50Y: COUNTERTOP DISPLAY € 134,40

Countertop display, yellow, 50 pieces

EAN: 5060172011643



BST30B: REFILL SMALL MODEL € 80,64

Refill small model, blue, 30 pieces

EAN: 5060172011698

BST30Y: REFILL SMALL MODEL € 80,64

Refill large model, Yellow, 30 pieces

EAN: 5060172011704

BROADFIX SHIMS AND WEDGES

BROADFIX SHIMS AND WEDGES. FOR EASY LEVELLING, PACKING AND SPACING.



For easy levelling, packing and spacing. Great ways to use this shim for window and door fitting, hardwood and laminate floor installation, decking and garden buildings, plus many more...

PW20EC € 7,56

WEDGES - GREEN: 20 PIECES
45 X 77 MM (Green)

EAN: 5060172013463



F6C30EC € 7,56

FLAT SHIM - RED: 30 PIECES
28 X 100 X 6MM

EAN: 5060172013500



F5C40EC € 7,56

FLAT SHIM - BLUE : 40 PIECES
28 X 100 X 5MM

EAN: 5060172013494



F4C50EC € 7,56

FLAT SHIM - BLACK: 50 PIECES
28 X 100 X 2MM

EAN: 5060172013487



FC16C60EC € 9,33

FLAT SHIM - 3 COLORS:
60 PIECES

28 X 100 X 1MM (White), 2MM (Black),
3mm (Green), 4mm (Gray, 5mm (Blue),
6mm (Red)

EAN: 5060172013456



F13C90EC € 9,33

FLAT SHIM - 3 COLORS:
90 PIECES

28 X 100 X 1MM (White),
2MM (Black), 3mm (Green)

EAN: 5060172013470



BSP120 € 15,58

FLAT SHIM BAG:
120 PIECES

28 X 100 X 1MM (White), 2MM (Black),
3mm (Green), 4mm (Gray, 5mm (Blue),
6mm (Red)

EAN: 5060172010134



BSP 300 € 30,25

FLAT SHIM BOX:
300 PIECES- 50 PIECES EACH

28 X 100 X 1MM (White), 2MM (Black),
3mm (Green), 4mm (Gray, 5mm (Blue),
6mm (Red)

EAN: 5060172010141



BGB 240 € 33,60

FLAT SHIM BOX:
240 PIECES- 40 PIECES EACH

28 X 100 X 1MM (White), 2MM (Black),
3mm (Green), 4mm (Gray, 5mm (Blue),
6mm (Red)

EAN: 5060172014163



BROADFIX FLAT SHIMS

UNIQUE FEATURES

- THE FLAT PLASTIC SPACERS BY BROADFIX WITH THE DIMENSIONS 100X28 MM ARE SUITABLE FOR ALIGNING AND FILLING IN CONSTRUCTIONS.
- THE PACKAGE CONTAINS 100 PIECES VARYING IN THICKNESS FROM 1MM TO 6MM.
- ENVIRONMENTALLY FRIENDLY: MADE FROM RECYCLED POLYPROPYLENE.



102801.100 € 6,68

FLAT SHIM - GREEN : 100 PIECES
28 X 100 X 1MM

EAN: 5060172014101



102802.100 € 7,16

FLAT SHIM - BLACK: 100 PIECES
28 X 100 X 2MM

EAN: 5060172014118



102803.100 € 7,68

FLAT SHIM - WHITE: 100 PIECES
28 X 100 X 3MM

EAN: 5060172014125



102804.100 € 8,44

FLAT SHIM - GREY: 100 PIECES
28 X 100 X 4MM

EAN: 5060172014132



102805.100 € 9,12

FLAT SHIM - BLUE: 100 PIECES
28 X 100 X 5MM

EAN: 5060172014149



102806.100 € 9,96

FLAT SHIM - RED : 100 PIECES
28 X 100 X 6MM

EAN: 5060172014156



BROADFIX U SHIMS

UNIQUE FEATURES

- **DISTINCTIVE DESIGN:** UNIQUE RETAINING COMB TO SLOT AROUND A SCREW OR NAIL.
- **DURABLE:** WATERPROOF, VERSATILE AND A HIGH COMPRESSIVE STRENGTH TESTED TO 25KN.
- **DIFFERENT THICKNESS:** AVAILABLE IN 6 THICKNESSES FROM 1MM TO 6 MM
- **ENVIRONMENTALLY FRIENDLY:** MADE FROM RECYCLED POLYPROPYLENE.



SMAB

€ 22,05

U SHIM - MIXED: 200 PIECES

Mixed bag of Small (55x43mm) and Standard (101x43mm) U Shims, 200 pcs total in a useful mix of various thicknesses

EAN: 5060216190075



ST1B

€ 18,66

U SHIM - YELLOW : 200 PIECES

55 x 43 x 1 mm

EAN: 5060216190006



ST2B

€ 21,60

U SHIM - GREEN: 200 PIECES

55 x 43 x 2 mm

EAN: 5060216190013



ST3B

€ 27,27

U SHIM - BLUE: 200 PIECES

55 x 43 x 3 mm

EAN: 5060216190020



ST4B

€ 31,92

U SHIM - RED: 200 PIECES

55 x 43 x 4 mm

EAN: 5060216190037



ST5B

€ 37,14

U SHIM - BROWN: 200 PIECES

55 x 43 x 5 mm

EAN: 5060216190044



ST6B

€ 42,53

U SHIM - BLACK : 200 PIECES

55 x 43 x 6 mm

EAN: 5060216190051



ST10B

€ 47,85

U SHIM - GREY : 200 PIECES

55 x 43 x 10 mm

EAN: 5060216190068



DIGGERS TOOLS

SYSTEM 1

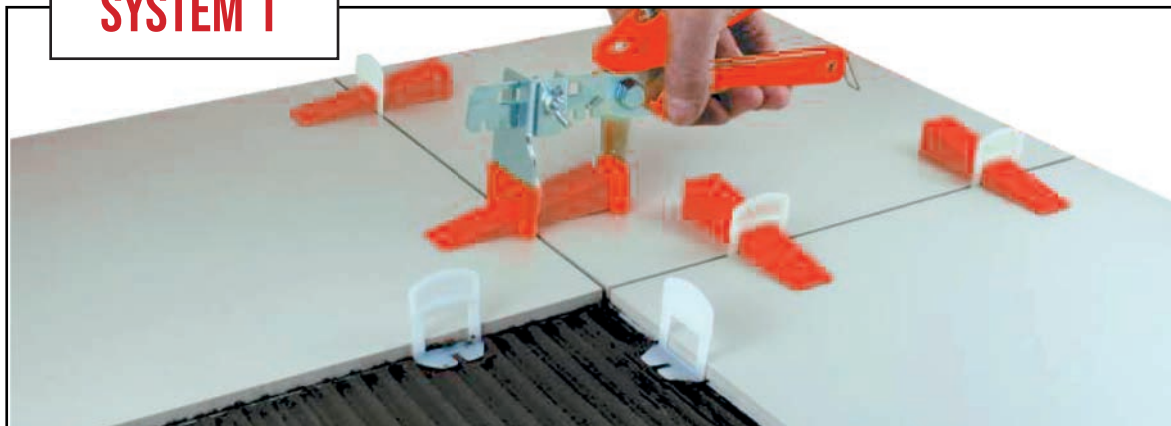

DIGGERS
tools

DIG729

€ 8,00

Wedges
50 PCS

EAN: 5425009852729



SPIE

DIGGERS
tools

DIG 736

€ 10,60

Tile Levelling Clips - 1 mm
100 PCS

EAN: 5425009852736



CLIP 1 MM

DIGGERS
tools

DIG743

€ 10,60

Tile Levelling Clips - 2 mm
100 PCS

EAN: 5425009852743



CLIP 2 MM

DIGGERS
tools

DIG521

€ 16,00

Tile leveler plier, system 1 & 2
For accurate cutting of mitres & butt joints

EAN: 5425009850521

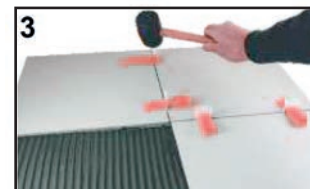
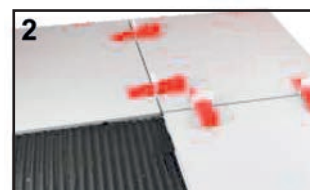

SYSTEM 2



DIGGERS
tools

DIG750

€ 31,60

TURN KNOB
50 PCS

EAN: 5425009852750



LINEAR



+ - SHAPED



TURN KNOB

DIGGERS
tools

DIG767

€ 12,80

Tile Levelling Clips - linear
100 PCS

EAN: 5425009852767



LINEAR



CLIP 2 MM

DIGGERS
tools

DIG774

€ 14,40

Tile Levelling Clips - CLIPS
100 PCS

EAN: 5425009852774



+ - SHAPED



CLIP 2 MM

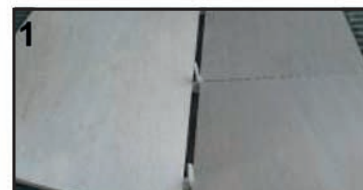
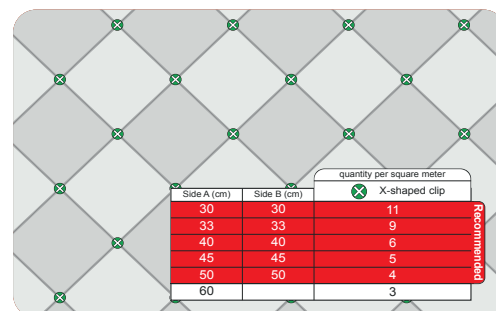
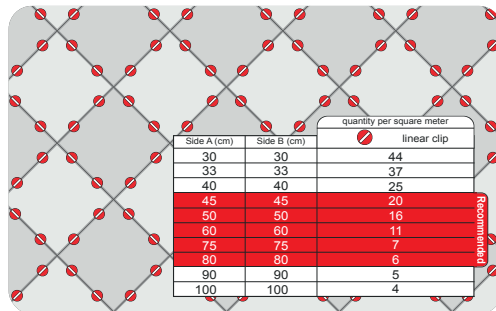

DIGGERS TOOLS

DIGGERS
tools

DIG176

€ 19,25

Diggers Level Hose 20 m
Hose comes with two gauge glasses with measuring scale. Intended for horizontal leveling of surface.

EAN: 5425009850176



DIGGERS
tools

DIG244

€ 2,28

Diggers Tile Wedges, 250 pieces
These red PVC tile wedges are indispensable when installing tiles.

EAN: 5425009850244



DIGGERS
tools

DIG213

€ 2,28

Diggers rubber scraper - 20 cm
Built rugged of rubber blade and lumber handle.

EAN: 5425009850213

DIGGERS
tools

DIG220

€ 3,19

Diggers rubber scraper - 30 cm
Built rugged of rubber blade and lumber handle.

EAN: 5425009850220



DIG213

DIG220

DIGGERS
tools

DIG251

€ 2,10

Diggers scraper 180mm, 6x6mm
Hose comes with two gauge glasses with measuring scale. Intended for horizontal leveling of surface.

EAN: 5425009850251

DIGGERS
tools

DIG268

€ 2,23

Diggers scraper fine, 180mm
Tile Leveling System Floor Plier Tool for 3-40mm Thick Wall Floor.

EAN: 5425009850268



DIG251

DIG268

DIGGERS
tools

DIG312

€ 6,80

Diggers mitre box, wood, 250x55x38mm
For accurate cutting of mitres & butt joints

EAN: 5425009850312

DIGGERS
tools

DIG329

€ 8,47

Diggers mitre box, wood, 300x55x38mm
For accurate cutting of mitres & butt joints

EAN: 5425009850329

DIGGERS
tools

DIG336

€ 12,00

Diggers mitre box, wood, 350x100x38mm
For accurate cutting of mitres & butt joints

EAN: 5425009850336



DIGGERS
tools

DIG422

€ 4,56

Miter Box: 250 x 50 x 35 mm

EAN: 5425009850442



DIGGERS
tools

DIG439

€ 10,42

Miter Box: 300 x 90 x 55 mm

EAN: 5425009852439



DIGGERS
tools

DIG446

€ 16,13

Miter Box: 310 x 125 x 80 mm

EAN: 5425009852446



DIGGERS
tools

DIG442

€ 10,69

Diggers mitre box with saw, plastic
Plastic molded miter box, Thin Kerf Saw for cutting
square ends, perfect splices and mitered corners.

EAN: 5425009850422



DIGGERS
home

DIG715

€ 6,10

Diggers DOOR STOP ø100 x H40 mm
Subjet to changes and/or any errors in images
and text. Dimensions and weights are guidelines only.

EAN: 5425009851715

DIGGERS
home

DIG722

€ 5,28

Diggers DOOR STOP ø90 x H75 mm
The door stop is a heavy duty version with
rubber band. The rubber band absorbs impacts
without damaging the door or wall.

EAN: 5425009851722

DIG722

DIG715



DIG078

DIGGERS
home

DIG061

€ 7,11

Diggers DOOR STOP ø100 x H40 mm
Subjet to changes and/or any errors in images
and text. Dimensions and weights are guidelines only.

EAN: 5425009853061

DIGGERS
home

DIG078

€ 5,41

Diggers DOOR STOP ø90 x H75 mm
The door stop is a heavy duty version with rubber band.
The rubber band absorbs impacts without damaging the
door or wall

EAN: 5425009853078



DIG061

DIGGERS TOOLS

DIGGERS
tools

DIG753

€ 18,58

3-part multi-angle ruler and tile hole finder

DIMENSIONS: 17,2 X 12,5 X 8 CM

- Six-fold ruler.
- 3 different diameters for holes.
- Ideal aid for installing tiles.
- Multi adjustable.
- Aluminium.

EAN: 5425009851753

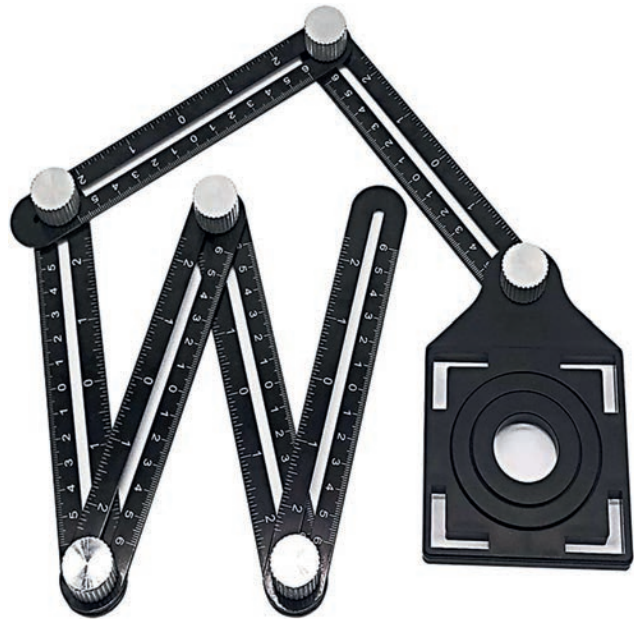
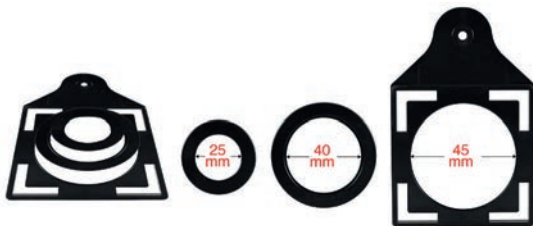

DIGGERS
tools

DIG739

€ 14,35

Marking aid 12x12cm

- Perfectly measures and recreates complex shapes.
- Secure locking system.
- Very handy for laminate, tiles, skirting boards, carpet, ...
- Accurate and easy to use.
- High-quality ABS material.

EAN: 5425009851739



DIGGERS
tools

DIG746

€ 22,32

Marking aid 13x25cm

- Perfectly measures and recreates complex shape.
- Secure locking system.
- Very handy for laminate, tiles, skirting boards, carpet, ...
- Accurate and easy to use.
- High-quality ABS material.

EAN: 5425009851746



1. Copy the irregular shape.



2. Secure the shape with the locking system.



3. The tension of the locking system can be adjusted.



1. Copy the irregular shape. 4. Transfer the shape onto the object.

DIGGERS POUCHES

DIGGERS
tools

DIG367

€ 19,97

Diggers 10 pocket pouch
Robust nylon, double stitched, 10 pockets.

EAN: 5425009850367



DIGGERS
tools

DIG374

€ 7,48

Diggers nail pouch
Robust nylon, double stitched

EAN: 5425009850374



DIGGERS
tools

DIG381

€ 34,06

Diggers double pouch
Robust nylon, double stitched, double holder

EAN: 5425009850381



DIGGERS
tools

DIG411

€ 6,66

Diggers hammer pouch
Robust nylon, double stitched, riveted metal ring

EAN: 5425009850411

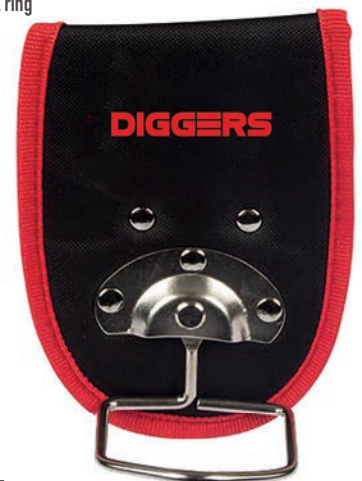

DIGGERS
tools

DIG428

€ 16,51

Diggers 7 pocket pouch
Robust nylon, double stitched, 7 pockets

EAN: 5425009850428



DIGGERS
tools

DIG435

€ 6,70

Diggers plier pouch
Robust nylon, double stitched

EAN: 5425009850435



DIGGERS POUCHES

DIGGERS
tools

DK583

€ 27,01

Warehouse Pouch

Compatible with all Quick klik pouches, Quick klik, compatible with every belt. Includes Quick klik, Smartphone pocket, Tape loop with metal hook

EAN: 5425009852583



DIGGERS
tools

DK590

€ 18,74

Tape Measure Pouch

Compatible with every belt, Quick klik, compatible with every belt. Includes Quick klik, 5 pockets, Works great alone holding a tape measure or a handful of nails.

EAN: 5425009852590



DIGGERS
tools

DK552

€ 47,43

FRAMER POUCH

Robust nylon, double stitched, compatible with all Quick klik pouches, Quick klik, compatible with every belt, includes Quick Klik, 9 pockets, multiple storage possibilities

EAN: 5425009852552



DIGGERS
tools

DK613

€ 29,15

All Purpose Pouch

Compatible with all Quick klik pouches, Quick klik, compatible with every belt. Includes Quick klik, Includes heavy duty hammer loop, 6 pockets, Tape measure clip

EAN: 5425009852613



DIGGERS
tools

DK620

€ 37,34

ELECTRICIAN POUCH

Compatible with all Quick klik pouches, Quick klik, compatible with every belt. Includes Quick klik, Adjustable pocket, Wire-tester pocket, Tape measure clip

EAN: 5425009852620



DIGGERS
tools

DK545

€ 36,58

CONTRACTOR POUCH

Robust nylon, double stitched, compatible with all Quick klik pouches, Quick klik, compatible with every belt. Includes Quick klik, Includes heavy duty hammer loop, Multiple storage possibilities

EAN: 5425009850367



DIGGERS
tools

DK606

€ 21,83

Small Drill Holster pouch
Compatible with every belt, Quick klik, compatible with every belt, Includes Quick klik, 5 pockets, Compact size, 3 drill bit pockets

EAN: 5425009852606



DIGGERS
tools

DK569

€ 19,29

TECHNICIAN POUCH
Robust nylon, double stitched, double holder, compatible with all Quick klik pouches, Quick klik, compatible with every belt, includes Quick klik, compact size, 11 pockets

EAN: 5425009852569



DIGGERS
tools

DK576

€ 26,10

Medium drill holster pouch
Robust nylon, double stitched, compatible with all Quick klik pouches, Quick klik, compatible with every belt, includes Quick klik, left and right handed, 13 pockets, compact size, 11 pockets

EAN: 5425009850575



DIGGERS
tools

DK637

€ 21,70

PLIERS POUCH
Compatible with all Quick klik pouches, Quick klik, compatible with every belt, Includes Quick klik, Fits pliers with large handles, Wire-tester pocket, Tape measure clip, 4 pockets

EAN: 5425009852637



DIGGERS
tools

DK668

€ 39,06

LARGE DRILL HOLSTER POUCH
Compatible with all Quick klik pouches: Quick klik, compatible with every belt, 15 pockets, Left and right handed, 7 storage compartments for drills and bits

EAN: 5425009850668



DIGGERS
tools

DK651

€ 13,89

smartphone Pouch
Steel clasp attaches to any belt, Fits most phones, Reliable pouch protects your smartphone

EAN: 5425009850651



DIGGERS POUCHES

DIGGERS
tools

DK699

€ 10,85

Hammer loop

Fits on any belt. Clips onto any belt or pocket. Extreme-duty steel loop. Retention strap firmly holds power cord in place. Rivet-reinforced ABS & steel withstand the harshest working environments

EAN: 5425009850699



DIGGERS
tools

DK675

€ 9,80

QUICK KLIK REPLACEMENT SET

3 pieces. The attachment point for all ClipTech pouches. Easily attach to any belt, Wall Organizer, ClipTech bag and tote. Screw holes allow Hubs to be attached anywhere.

EAN: 5425009850675



DIGGERS
tools

DK538

€ 20,86

PADDED BELT WITH QUICK RELEASE BUCKLE

Robust nylon, double stitched, quick release buckle, compatible with all 'Quick Klik' products, adjustable to all waists, comfortable padding, compatible with DK682

EAN: 5425009850428



DIGGERS
tools

DK644

€ 10,82

WORKBELT

Customizable belt length. Clamp-on steel tip allows belt to be cut, and cleanly, finished to custom length. Adjustable from 80 to 122 cm. Heavy-duty belt buckle

EAN: 5425009850644



DIGGERS
tools

DK781

€ 69,17

Gel knee pads

Tight support, durable. Embrace the knee, upper shin and thigh. Allows flexible movement, does not rotate. Maximum comfort. Adjustable fit

EAN: 5425009850435



DIGGERS CLAMPS

DIGGERS
tools

BI-MATERIAL HANDLE F CLAMP



PRODUCT	SIZE MM	CLAMPING FORCE	PRICE	EAN-CODE	PIECES
DIG309	120 x 300	470 kg	€ 18,47	5425009852309	12
DIG316	120 x 400	470 kg	€ 19,94	5425009852316	10
DIG323	120 x 500	470 kg	€ 21,46	5425009852323	10
DIG330	120 x 600	470 kg	€ 22,97	5425009852330	10
DIG347	120 x 800	470 kg	€ 26,06	5425009852347	10
DIG354	120 x 1000	470 kg	€ 29,16	5425009852354	6

DIGGERS
tools

F CLAMP

NEW



PRODUCT	SIZE MM	CLAMPING FORCE	PRICE	EAN-CODE	PIECES
DIG191	80 x 300	275 kg	€ 13,79	5425009853191	20
DIG207	80 x 400	275 kg	€ 15,32	5425009853207	20
DIG214	80 x 500	275 kg	€ 17,56	5425009853214	10
DIG221	80 x 600	275 kg	€ 18,72	5425009853221	10

DIGGERS CLAMPS

DIGGERS
tools

BI-MATERIAL HANDLE F CLAMP



PRODUCT	SIZE MM	CLAMPING FORCE	PRICE	EAN-CODE	PIECES
DIG255	50 x 100	170 kg	€ 5,98	5425009852255	30
DIG262	50 x 150	170 kg	€ 6,16	5425009852262	30
DIG279	50 x 200	170 kg	€ 6,54	5425009852279	30
DIG286	50 x 250	170 kg	€ 6,66	5425009852286	30
DIG293	50 x 300	170 kg	€ 6,84	5425009852293	30

DIGGERS
tools

HEAVY DUTY BAR CLAMP



PRODUCT	SIZE MM	PRICE	EAN-CODE	PIECES
DIG170	60 x 150	€ 11,63	5425009852170	12
DIG194	80 x 150	€ 17,72	5425009852194	12
DIG187	60 x 300	€ 13,10	5425009852187	12
DIG200	80 x 300	€ 19,19	5425009852200	12
DIG217	80 x 450	€ 20,66	5425009852217	12
DIG224	80 x 750	€ 23,86	5425009852224	8
DIG231	80 x 900	€ 25,79	5425009852231	8

DIGGERS
tools

HEAVY DUTY LEVER CLAMP



DIG361

DIG378

DIG385

PRODUCT	SIZE MM	CLAMPING FORCE	PRICE	EAN-CODE	PIECES
DIG361	80 x 200	122 kg	€ 14,03	5425009852361	12
DIG378	80 x 300	122 kg	€ 14,03	5425009852378	12
DIG385	100 x 400	137 kg	€ 18,56	5425009852385	12

DIGGERS
tools

SPRING CLAMPS



PRODUCT	LENGTH	CLAMPING CAPACITY	PRICE	EAN-CODE
DIG149	175 mm	75 mm	€ 3,09	5425009852149
DIG132	150 mm	63 mm	€ 2,81	5425009852132
DIG125	115 mm	50 mm	€ 2,34	5425009852125

DIGGERS
tools

DIG163

€ 6,59

2" Ratchet Spring Clamp
Clamping Capacity: 50mm
Length: 200mm

EAN: 5425009852163



DIGGERS
tools

DIG392

€ 3,19

QUICK RELEASE CLAMP
Clamping Force: 25 kg
Depth: 30 mm, Clamping Capacity: 50 mm

EAN: 5425009852392



DIGGERS
tools

DIG415

€ 16,51

Belt Clamp
• Ideal for clamping frames and unusual shaped workpiece
• Quick fixing
• 4 variable angle adaptors

EAN: 5425009852415



DIGGERS
tools

DIG156

€ 2,75

Large Depth Spring Clamp
• Strong engineering-grade plastics in compliance with RoHS and REACH
• Large depth for reaching workpiece far from edge
• Special-grade spring steel for increased durability
• Long and pointed arms for working in narrow space

EAN: 5425009852156



DIGGERS CLAMPS

DIGGERS
tools

DIG118

€ 6,75

Spring Clamps, 8 PIECES
Clamping capacity: 25 mm
Universal clamps with high resilience.
Convenient for use in household,
workplace, photography, etc....

EAN: 5425009852118



DIGGERS
tools

DIG248

€ 5,32

SILICON SPREADER SET, 4 PIECES
SILICONE SPREADER SET

Set of 4 flat spatulas for silicone, grout, adhesive
or acrylic joints. Made of thermoplastic rubber (TPR).
Covers every edge, corner and joint from 0 mm to 28 mm.
Professional, neat finish. Used for rough or smooth surfaces.
No need to dampen surface or tricky pre-masking.

EAN: 5425009852248



DIGGERS
tools

DIG408

€ 9,48

Angle Clamp

- Equipped with quick-adjustment spindles.
- Equipped with mounting foot with various mounting slots and holes.
- Aluminium clamp with steel spindles.
- Suitable for wood and metalworking.

EAN: 5425009852408



DIGGERS
tools

DIG160

€ 11,00

Screw Clamp

- Dimensions: 50x300mm
- Equipped with high-quality 2-component plastic handle and replacable pressure plates.
- Equipped with stable profiled rail, anti-slip system, with protective caps on the clamping surfaces.

EAN: 5425009853160



DIGGERS WELDING HELMET

DIGGERS
tools

TS357: AUTO-DARKENING FILTER WELDING HELMET € 67,31

Viewing Area: 98 x 43 mm (3.86" x 1.69")
 Size of Cartridge: 110 x 90 x 9 mm (4.33" x 3.54" x 0.35")
 UV/IR Protection : Up To Shade DIN16 at all time
 Light State: Shade DIN 4
 Variable Shade: From DIN 9 to DIN 13
 Power On/Off: Fully Automatic
 Function: "WELDING"/ "GRINDING" can be selective
 Switching Time:
 Light to Dark: 1/30000 s (0.000033 sec) - (- 5°C , 0.0008 sec)
 Dark to Light: 0.25~ 0.8 s (short - --- long)
 Operating Temperature: - 5°C to + 55°C (23°F to 131°F)
 Storing Temperature: - 20°C ~ + 70°C (-4 ° F to 158° F)
 Helmet Material: High-impact resistant plastic / Polyamide (Nylon)

Total Weight: 435 gr or 450gr
 T357: BLUE MODEL:

EAN: 5425009851036



DIGGERS
tools

TS361: AUTO-DARKENING FILTER WELDING HELMET € 76,08

Flames welding helmet

EAN: 5425009851043



DIGGERS MICROFIBRE WIPES

DIGGERS
tools

DIG900: MULTI-PURPOSE MICROFIBRE CLEANING WIPES € 16,52

Reusable Microfiber Cleaning Wipes with Dispenser Box.
 Pack of 50; Safe to use on any surface; for wet or dry use;
 scratch free cleaning and detailing; Remove dirt, grease, oil,
 and smudges. Non abrasive cloths are ideal for home, school,
 office, vehicle, garage, workshop, bathroom, playroom and
 more; easy pull-use-re-use method; Reusable and durable;
 Machine washable; Edgeless wipe finish. The size of each
 rag is 30*30CM and each rag can be reused.

Quantity: 50 reusable wipes
 Material: 90% polyester and 10% polyamide
 Color: blue
 Product size: 30CM*30CM
 Gross weight: 16.26



EAN: 5425009853900



DIGGERS DOLLIES

DIGGERS
tools

DIG771: MOVING DOLLY, 29X29CM

€ 10,14

MDF moving dolly for heavy moving applications. With hard PP wheels.
Footplate size 29 x 29cm – Wheels Ø5cm
Can carry up to: 200 kg
Contains 12 pieces/box

EAN: 5425009853771



DIGGERS
tools

DIG788: MOVING DOLLY, 58X29CM

€ 14,40

MDF moving dolly for heavy moving applications. With hard PP wheels.
Footplate size 58 x 29cm – Wheels Ø5cm
Can carry up to: 150 kg
Contains 6 pieces/box

EAN: 5425009853788



DIGGERS
tools

DIG795: MOVING DOLLY, 58X29CM

€ 20,60

MDF moving dolly for heavy moving applications. With soft PP wheels.
Footplate size 58 x 29cm – Wheels Ø7,5cm
Can carry up to: 200 kg
Contains 6 pieces/box

EAN: 5425009853795



DIGGERS
tools

DIG801: MOVING DOLLY, 58X30CM

€ 36,40

Plywood moving dolly for heavy moving applications. With rubber and steel wheels.
Footplate size 58 x 30cm – Wheels Ø9,5cm – Including break
Can carry up to: 400 kg
Contains 4 pieces/box

EAN: 5425009853801



DIGGERS
tools

DIG818: MOVING DOLLY, 65X40CM

€ 42,64

Plywood moving dolly for heavy moving applications. With hard PP wheels.
Footplate size 65 x 40cm – Wheels Ø10cm
Can carry up to: 400 kg
Contains 4 pieces/box

EAN: 5425009853818



DIGGERS
tools

DIG825: MOVING DOLLY, 58X29CM

€ 21,65

Plywood moving dolly for heavy moving applications. With TPR wheels.
Footplate size 58 x 29cm – Wheels Ø7,5cm
Can carry up to: 200 kg
Contains 6 pieces/box

EAN: 5425009853825



HAND AND PLATFORM TRUCKS

STANLEY

MS572: PLYWOOD MOVING DOLLY, 200 KG

€ 32,12

Extra strong plywood dollies for heavy moving applications.
Footplate size 45 x 30cm
Weight: 2.5 kg

EAN: 8717496635723



STANLEY

HT513: ALUMINIUM HAND TRUCK - 200 KG

€ 201,56

Capacity: 70/137kg,
Weight: 7,7kg
Dimensions: 40,5 x 12,5 x 66cm
Base Plate: 28 x 38,8cm
Wheels: 8,7 / 12cm
Material: Aluminium

EAN: 8717496635136



STANLEY

HT522: STEEL HAND TRUCK - 200 KG

€ 70,20

Footplate size 240 x 360 mm
Overall size 520 x 1180 x 530 mm
Wheel Diameter Pneumatic tire 260 mm
WEIGHT: 9,2kg

EAN: 8717496635228



STANLEY

HT523: STEEL HAND TRUCK - 6 WHEELS - 200 KG

€ 104,38

Unique 3-wheeled Design for easy movement over obstacles, thresholds and stairs
Footplate size 240 x 300 mm
Overall size 620 x 1190 x 510 mm
Wheel Diameter 150 mm
Weight: 13,4kg

EAN: 8717496635235



STANLEY

HT524: STEEL HAND TRUCK - 250 KG

€ 80,63

Large pneumatic wheels allow for easy movement indoors and outdoors
Footplate size 240 x 300 mm
Overall size 500 x 1190 x 550 mm
Wheel Diameter Pneumatic tire 260 mm
Weight 10,5 Kg

EAN: 8717496635242



STANLEY

HT525: ALUMINIUM HAND TRUCK - 200 KG

€ 146,64

Large pneumatic wheels allow for easy movement indoors and outdoors
Footplate size 200 x 400 mm
Overall size 490 x 1170 x 515 mm
Wheel Diameter Pneumatic tire 260 mm
Weight 7 Kg

EAN: 8717496635259



STANLEY

HT526: STEEL HANDTRUCK - 300 KG

€ 75,19

Large pneumatic wheels allow for easy movement indoors and outdoors
Footplate size 200 x 400 mm
Overall size 470 x 620 x 1140 mm
Wheel Diameter Pneumatic tire 260 mm
Weight 11 Kg

EAN: 8717496635266



STANLEY

HT535: STEEL HANDTRUCK - 200 KG

€ 85,50

Guides on the back allow for easy handling of large obstacles on stairs
Extra large loading platform: 420 x 170 mm
Overall size (extended): 770 x 590 x 1105 mm
Overall size (folded): 430 x 590 x 1105 mm
Wheel Diameter: Pneumatic Tire 260 mm
Weight 11,4 Kg

EAN: 8717496635358



HAND AND PLATFORM TRUCKS

STANLEY

MT515: MULTI TRUCK, 200 KG CAPACITY

€ 295,68

Capacity: 70/137kg,
Weight: 7.7kg
Dimensions: 40,5 x 12,5 x 66cm
Base Plate: 28 x 38,8cm
Wheels: 8,7 / 12cm
Material: Aluminium

EAN: 8717496635853



STANLEY

MT519: STEEL MULTI TRUCK - 150/200KG

€ 110,14

Made of durable steel. Guides on the back allow for easy handling of large obstacles on stairs
Footplate size: 355 x 220 mm
Overall size: 460 x 580 x 1435 mm
Wheel Diameter: Pneumatic Tire 260 mm
WEIGHT: 13,4kg

EAN: 8717496635198



STANLEY

PC508: PLATFORM TRUCK 150KG

€ 111,25

Fully assembled with lightweight durable construction. Folding design allows the SXWTC-PC507 to be used as versatile dolly, ideal for larger objects

EAN: 8717496635082



STANLEY

PC510: ALUMINIUM PLATFORM TRUCK - 150 KG

€ 134,13

4-wheeled professional platform truck, folds and opens in seconds
Robust design made of lightweight and durable aluminium
Strong steel rigid handle for secure maneuvering of loads
Built for commercial warehouses, retail stores, delivery services and professional movers

EAN: 8717496635105



STANLEY

PC511: ALUMINIUM PLATFORM TRUCK - 250 KG

€ 205,95

4-wheeled professional platform truck, folds and opens in seconds
Robust design made of lightweight and durable aluminium
Built for commercial warehouses, retail stores, delivery services and professional movers

EAN: 8717496635112



STANLEY

PC512: ALUMINIUM PLATFORM TRUCK - 350 KG

€ 228,95

Heavy duty 4-wheeled professional platform truck, folds and opens in seconds.
Robust frame made of lightweight and durable aluminium
Plastic handles for comfortable use
Built for commercial warehouses, retail stores, delivery services and professional movers

EAN: 8717496635129



STANLEY

PC517: PLATFORM TRUCK 120KG

€ 117,19

Capacity: 70/137kg,
Weight: 7.7kg
Dimensions: 40,5 x 12,5 x 66cm
Base Plate: 28 x 38,8cm
Wheels: 8,7 / 12cm
Material: Aluminium

EAN: 8717496635174



STANLEY

PC527: STEEL PLATFORM TRUCK - 150 KG

€ 76,13

Steel wheeled platform truck folds and opens in seconds
Tubing and platform made of tough steel for added durability
Strong, rigid, steel handle for secure maneuvering of loads
4 ball bearing braked wheels for easy and safe steering
Compact design for easy storage

EAN: 8717496635273



HAND AND PLATFORM TRUCKS

FT501: Fully compatible with FT505 Folding Utility Basket.

- Folds and opens in seconds
- Easy to use and store and comes 100% fully assembled.
- Compact design made of lightweight and durable aluminium
- Major plastic stress points made of durable plastic
- Soft grip handle for added comfort
- Includes elastic bungee cord in built in storage container
- Compact design - for easy storage almost anywhere
- Silent TPR wheels

FT584: The wheels make sure it is easy to manoeuvre on stairs, thresholds, curbstones and other obstacles.

- Folds and opens in seconds. Easy to Use and Store
- Comes 100% fully assembled
- Made of strong durable steel. Major plastic stress points are made of durable nylon; other pieces are polypropylene
- Adjustable TPR grip handle
- Comes with a bungee cord to safely strap loads onto the hand truck

STANLEY

PC528: STEEL PLATFORM TRUCK - 300 KG

€ 152,10

Steel wheeled platform truck folds and opens in seconds
Tubing and platform made of tough steel for added durability
Strong, rigid, steel handle for secure maneuvering of loads
4 ball bearing wheels for easy and safe steering
Compact design for easy storage

EAN: 8717496635280



STANLEY

FT501: FOLDING HAND TRUCK 60KG + WITH BASKET HOLDER

€ 55,95

Folding Hand Truck 60Kg. with basket holder
Capacity: 60kg.
Weight: 3,34kg
Dimensions: 40 x 41 x 100cm
Base Plate: 38 x 28cm
Wheels: 12,7cm
Material: Aluminium

EAN: 8717496635013



STANLEY

FT505: STANLEY FOLDING BASKET, 25 KG

€ 28,20

Capacity: 25kg.
Weight: 2kg
Dimensions: 55,8 x 41 x 27cm
Material: Polypropylene

EAN: 8717496635051



STANLEY

FT516: FOLDING HAND TRUCK 60KG

€ 49,95

Capacity: 70/137kg.
Weight: 7,7kg
Dimensions: 40,5 x 12,5 x 66cm
Base Plate: 28 x 38,8cm
Wheels: 8,7 / 12cm
Material: Aluminium

EAN: 8717496635853



STANLEY

FT520: STEEL FOLDING HAND TRUCK - 120 KG

€ 116,75

Large pneumatic wheels allow for easy movement
Footplate size 290 x 310 mm
Weight: 10 Kg

EAN: 8717496635204



STANLEY

FT521: STEEL FOLDING HAND TRUCK - 6 WHEELS - 120 KG

€ 129,25

Unique 3-wheeled Design for easy movement over obstacles, thresholds and stairs
Top frame slides into bottom frame for convenient storage
Footplate size 290 x 310 mm
Overall size(extended) 680 x 1130 x 49 mm
Weight: 10 Kg

EAN: 8717496635211



HAND AND PLATFORM TRUCKS + WHEELBARROW

STANLEY

FT580: FOLDING HAND TRUCK 70KG

€ 47,95

Capacity: 70kg.
Weight: 4,5kg
Dimensions: 42 x 40 x 102cm
Base Plate: 39 x 29cm
Wheels: 12,7cm
Material: Steel

EAN: 8717496635808



STANLEY

FT582: FOLDING HAND TRUCK 90KG

€ 68,95

Capacity: 90kg.
Weight: 5,5kg
Dimensions: 44 x 49 x 98cm
Base Plate: 49 x 28cm
Wheels: 17,5cm
Material: Steel

EAN: 8717496635922

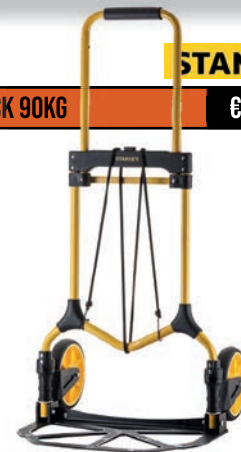

STANLEY

FT584: FOLDING STAIR CLIMBER 30/60KG

€ 57,95

Folding Hand Truck 30/60Kg.
Capacity: 60kg.
Weight: 4,7kg
Dimensions: 40 x 40 x 120cm
Base Plate: 39 x 29cm
Wheels: 5,6cm
Material: Steel

EAN: 8717496635846



STANLEY

FT-591: HAND TRUCK 300 KG

€ 125,00

Folding Hand Truck 300/60Kg.
Capacity: 300kg.
Weight: 8kg
Dimensions: 117x15,8x45 cm
Base Plate: 33,3x30,7 cm
Wheels: 20 cm
Material: Steel

EAN: 8717496637659



STANLEY

FT585: 2-IN-1 FOLDING TRUCK 70/137 KG

€ 121,73

Capacity: 70/137kg.
Weight: 7,7kg
Dimensions: 40,5 x 12,5 x 66cm
Base Plate: 28 x 38,8cm
Wheels: 8,7 / 12cm
Material: Aluminium

EAN: 8717496635853



HAND AND PLATFORM TRUCKS

DEWALT

DXWT-500

€ 237,60

Product Specifications: Extra Wide & Extendable platform, Load protector strips, Knuckle-guard & P-handle loop grip, Obstacle skid guides. Load capacity: 300kg
Wheel: PU Flat-free DXWT-950, Wheel diam: 260mm
Load plate thickness: 3mm? Tube thickness: 1.5mm
Size: 1280x550x470, Weels: 260mm (~10 inch)
Baseplate: 550x230x3mm, Weight: 16.90 KG

EAN: 8717496637284



DEWALT

DXWT-501

€ 192,00

Product Specifications: Load protector strips, P-handle loop grip, Load capacity: 300kg, Wheels: PU Flat-free DXWT-950, Wheel diam: 260mm, Load plate thickness: 3mm
Size: 1280x540x470
Weels: 260mm (~10 inch)
Baseplate: 400x230x3mm
Weight: 13.90 KG

EAN: 8717496637291



DEWALT

DXWT-502

€ 192,00

Product Specifications: Load protector strips, Knuckle-guard grip, Load capacity: 300kg, Wheels: PU Flat-free DXWT-950, Wheel diam: 260mm, Load plate thickness: 3mm
Tube thickness: 1.5mm
Size: 1280x540x470
Weels: 260mm (~10 inch)
Baseplate: 400x230x3mm
Weight: 13.60 KG

EAN: 8717496637307



DEWALT

DXWT-504

€ 237,60

Product Specifications: Foldable loop handle, Steel loading platform 2 Swivel casters can be mounted front or back, Load capacity: 300kg
Wheels: PU Flat-free DXWT-509 & DXWT-510
Wheel diam: 200mm, Size: 915x615x864 mm
Weels: 200mm (~8 inch), Baseplate: 800x600mm
Weight: 21.00 KG

EAN: 8717496637321



DEWALT

DXWT-510

€ 30,58

Product Specifications: 200mm Swivel Caster with PU Flat-free Wheel Black hub and bracket, Replacement wheel for Trucks:
DXWT-504, DXWT-504, Weels: 200mm (~8 inch), Weight: 2.73 KG

EAN: 8717496637376



DEWALT

DXWT-200

€ 148,80

Product Specifications: 2350kg capacity, 0-80mm clamping action, 300mm steelcore flat free wheels, 4kg weight, Size: 340x440x410 mm, Weels: 300mm (12"), 0-80mm Clamping Action, Weight: 5.80 KG

EAN: 8717496636805



DEWALT

DXWT-201

€ 168,00

Product Specifications: 350kg capacity, 40-120mm clamping action 300mm steelcore flat free wheels, 6kg weight,
Size: 340x480x410 mm, Weels: 300mm (12"), 0-120mm Clamping Action, Weight: 6.00 KG

EAN: 8717496636812



DEWALT

DXWT-202

€ 287,50

Product Specifications: 500kg Load capacity
Size: 215x430x1040 mm, Weels: 300mm (12")
0-80mm Clamping Action, Weight: 5.80 KG

EAN: 8717496636829



VACUUM CLEANERS + ACCESSORIES

DEWALT

DXV15T: TOOLBOX 15L WET/DRY VACUUM CLEANER

€ 151,65

Compact 'Toolbox' design. Rugged and quality plastic casing. Power cord wrap reduce overall storage space. On-board accessory storage bin. Blower feature for removing dust & debris. Large on/off switch with water-resistant design for quick access. Lightweight design for easy portability.

Product Specifications: 15L capacity, 230V/50Hz voltage, seal pressure (Kpa)/230V: 12, 1100W power, air flow (EU L/S): 42.5, 4.8M cord length, flexible \varnothing 48MM*(0.53M-2.1M) hose, packaging size (LxBxHLxBxH): 52CM*38.5CM*36.5CM.



EAN 6921183087173

DEWALT

DXV20P: POLY 20L WET/DRY VACUUM CLEANER

€ 117,83

Power cord wrap reduce overall storage space. Lightweight design for easy portability. Large on/off switch with water-resistant design for quick access. Rubberized Non Marring Casters for smooth & easy movement across all surfaces. Hose strap for easy cord organization. Quick-connect locking hose system for easy but secure connection. Powerful blower port instantly converts the vacuum into a blower.

Product Specifications: 20L capacity, 230V/50Hz voltage, seal pressure (Kpa)/230V: 15, 1050W power, air flow (EU L/S): 37.8, 3M cord length, \varnothing 48mm*2.1M hose, packaging size (LxBxHLxBxH): 38CM*35CM*50CM.

EAN 6921183087630



DEWALT

DXV20PTA: POLY 20L WET/DRY VACUUM CLEANER WITH PTA

€ 141,92

With "Power Tool Activation" (PTA), Rugged and quality plastic tank. Powerful blower port instantly converts the vacuum into a blower. Large on/off switch with water-resistant design for quick access. Hose strap for easy cord organization. Quick-connect locking hose system for easy but secure connection. Rubberized Non Marring Casters for smooth & easy movement across all surfaces.

Product Specifications: 20L capacity, 230V/50Hz voltage, seal pressure (Kpa)/230V: 15, 1050W power, air flow (EU L/S): 37.8, 3M cord length, \varnothing 48MM*2.1M hose, packaging size (LxBxHLxBxH): 38CM*35CM*50CM.



DEWALT

DXV30SAPTA: SS 30L WET/DRY VACUUM CLEANER WITH PTA

€ 169,63

With "Power Tool Activation" (PTA), 30L Stainless Steel quality tank. Hose strap for easy cord organization. Power cord wrap reduce overall storage space. Powerful blower port instantly converts the vacuum into a blower. Large on/off switch with water-resistant design for quick access. Quick-connect locking hose system for easy but secure connection. Rubberized Non Marring Casters for smooth & easy movement across all surfaces. Built-in drain port allows for convenient emptying of liquids.

Product Specifications: 30L capacity, 230V/50Hz voltage, seal pressure (Kpa)/230V: 15, 1050W power, air flow (EU L/S): 37.8, 3M cord length, \varnothing 48mm*2.1M hose, packaging size (LxBxHLxBxH): 39.5CM*38.5CM*63CM.

EAN 6921183087678



DEWALT

DXV34P-QT: POLY 34L QUIET WET/DRY VACUUM CLEANER

€ 198,97

Quiet technology: Provides 50% quieter operation. Power cord wrap reduce overall storage space. Large on/off switch with water-resistant design for quick access. Hose strap for easy cord organization. Quick-connect locking hose system for easy but secure connection. Rubberized Non Marring Casters for smooth & easy movement across all surfaces. Built-in drain port allows for convenient emptying of liquids. Accessory storage bag gets all accessories in reach.

Product Specifications: 34L capacity, 230V/50Hz voltage, seal pressure (Kpa)/230V: 19, 960W power, air flow (EU L/S): 35, 3M cord length, \varnothing 48MM*2.1M hose, packaging size (LxBxHLxBxH): 47CM*45.5CM*57.5CM.



DEWALT

DXA19-4201

€ 19,80

Dust bag for 23-38L
Amount: 3 pieces



VACUUM CLEANER ACCESSORIES + COOLING FANS

DEWALT

DXA19-4204

Dust bag for 20-30L
Amount: 3 pieces



DEWALT

DXA25-4240

Dust bag for toolbox
Amount: 3 pieces



DEWALT

DXVC4001: CARTRIDGE FILTER

€ 26,22

Regular for toolbox
Amount: 1 piece



DEWALT

DXVC6910: CARTRIDGE FILTER

€ 27,85

Regular for 23-61L
Amount: 1 piece



DEWALT

DXF1645: 40CM BENCHTOP FAN

€ 141,09

Silent in operation, less than 60 dB(A). Multiple hanging options: freestanding, hang hooks, and wall mount. 1.8m grounded power cord with fuse for adequate safety. Sturdy handle for easy carrying. Built-in cord wrap design for easy storage. 360 -Degree tilting fan Head to direct airflow up or down as desired. 3 Speed settings provide varying levels of air flow. Nonskid feet for operational stability.

Product Specifications:
40CM fan size, 110W motor, air flow (L/s): 496 ±5%, speed: 3, noise: ≤60dB(A), direct driven, blade: 3, cord type: H05VV-F, 3C*0.75mm 0.75mm², 1.8M cord, 3 years warranty, packaging size: 560MM*290MM*525MM.

EAN 6921183000844

NEW



COOLING FANS

DEWALT

DXF2067: 51CM DRUM FAN

€ 166,53

Silent in operation, less than 63 dB(A), 1.8m grounded power cord with fuse for adequate safety. Rotation angle can be adjusted to direct the direction of air flow and dynamic circulation according to different needs. Sturdy handle for easy carrying. Built-in Cord Wrap design for easy storage. 3 Speed settings provide varying levels of air flow. Nonskid feet for operational stability. Unique drum and air hood design increases air flow.

Product Specifications:

51CM fan size, 110W motor, air flow (L/s): 669 ±5%, speed: 3, noise: ≤63dB(A), direct driven, blade: 3, cord type: H05VV-F, 3C*0.75mm 0.75mm², 1.8M cord, 3 years warranty, packaging size: 720MM*250MM*645MM.

EAN 6921183000905

NEW



DEWALT

DDXF2410: 61CM DRUM FAN

€ 244,90

Silent in operation, less than 66 dB(A). Grounded power cord with fuse, safe enough, and 3.6 meters long enough to allow you to easily reach the desired range. Rotation angle can be adjusted to direct the direction of air flow and dynamic circulation according to different needs. Built-in Cord Wrap design for easy storage. Stepless Speed setting gives you the freedom to adjust the air speed to whatever you want. Nonskid feet for operational stability. Folding handle and large wheels provide easier transport.

Product Specifications:

61CM fan size, 220W motor, air flow (L/s): 1021 ±5%, speed: stepless, noise: ≤66dB(A), direct driven, blade: 3, cord type: H05VV-F, 3C*0.75mm 0.75mm², 3.6M cord, 3 years warranty, packaging size: 830MM*280MM*773MM.

EAN 6921183000912

NEW



DEWALT

DXAM2250: TURBOVENTILATOR

€ 103,29

3-Speed Operation to conveniently control air flow, sturdy handle for easy lifting and carrying. 3 user positions, flat, 45 degrees, and 90 degrees. 3 m power cord with built-in wrapping.

Product Specifications:

130W motor, air flow (L/s): 177, rotate speed: Type 1, noise: ≤60dB(A), direct driven, operating position: 0°-45°-90°, cord type: H05RN-F, 3C*0.75mm², 3M cord, 3 years warranty, packaging size: 332MM*324MM*332MM.

EAN 6921183077013

NEW



MARKERS TRADES-MARKER

MARKAL[®]

THE MARK OF WORK[™]



MARKERS TRADES-MARKER

MARKAL

TRADES-MARKER® DRY



TRADES-MARKER® Dry is a graphite clutch pencil with an extended fine tip. Fully designed in metal for more resistance than plastic holder, it incorporates a convenient sharpener and a clip. It can also be used with color leads for bright and dark surfaces, or with Welding refills featuring Silver Streak and Red Riter leads.

ITEM NR	PRODUCT EAN13	CONTENT	BOX	CASE	PRICE
96260	3660447110228	HOLDER + 1 GRAPHITE LEAD	10	100	€ 14,74

MARKAL

TRADES-MARKER® DRY REFILLS

Refills for Trades-Marker® Dry. Pack of 6.

ITEM NR	PRODUCT EAN13	CONTENT	BOX	CASE	PRICE
96262	3660447110204	6 X GRAPHITE	1	50	€ 5,56
96263	3660447110211	2X GRAPH. 2X RED 2X YELLOW	1	50	€ 5,56
96265	3660447110242	6 X RED	1	50	€ 5,56
96266	3660447110259	6 X YELLOW	1	50	€ 5,56
96267	0048615962672	6 X SILVER STREAK	1	50	€ 18,17
96268	0048615962689	6 X RED RITER	1	50	€ 18,17



MARKAL

TRADES-MARKER® DRY - DISPLAY

Display including 20 Trades-Marker® Dry and 20 Refills Pack

ITEM NR	PRODUCT EAN13	COLOR	BOX	CASE	PRICE
96261	3660447110266	MIX	1	1	€ 406,06



MARKAL

TRADES-MARKER® DRY - RETAIL PACK

Pack containing 1 TRADES-MARKER® Dry + 1 pack of refills, or 1 pack of refills alone

ITEM NR	PRODUCT EAN13	COLOR	BOX	CASE	PRICE
96264	3660447110235	HOLDER + MIX COLORED LEADS	1	12	€ 22,52
96281	3660447110297	HOLDER + 6 SILVER STREAK LEADS	1	12	€ 34,18
22223	3660447222235	1 PACK OF RED	1	12	€ 9,13
22224	3660447222242	1 PACK OF YELLOW	1	12	€ 9,13
22225	3660447222259	1 PACK OF GRAPHITE	1	12	€ 9,13
22226	3660447222266	1 PACK OF MIX MIX	1	12	€ 9,13
22227	3660447222273	1 PACK OF SILVER-STREAK SILVER	1	12	€ 19,76
22228	3660447222280	1 PACK OF RED RITER	1	12	€ 19,76



MARKERS DURA-INK

MARKAL

DURA-INK® 5



The DURA-INK 5 is a permanent ink marker that uses an extended micro tip for precision marking needs and is ideal to use through drill holes, mounting brackets, or in any hard to reach area. The industrial-strength ink dries quickly on almost any surface and is wear- and weather-resistant.

ITEM NR	PRODUCT EAN13	COLOR	BOX	CASE	PRICE
96520	0048615965208	BLACK	12	24	€ 2,86
96522	0048615965222	RED	12	24	€ 2,86
96519	0048615965192	BLUE	12	24	€ 2,86

MARKAL

DURA-INK® 5 - DISPLAY

Display including 44 Dura-Ink® 5. Total 44 markers Blue 8x, Red 12x, Black 24x.

ITEM NR	PRODUCT EAN13	CONTENT	COLOR	BOX	CASE	PRICE
199010	3660447400053	44 MARKERS		1	1	€ 129,23
			8 X BLUE			
			12 X RED			
			24 X BLACK			



MARKAL

DURA-INK 5® - RETAIL PACK

Pack containing 4 DURA-INK® 5 ink markers

ITEM NR	PRODUCT EAN13	COLOR	BOX	CASE	PRICE
22242	3660447222426	2 BLACK + 1 RED + 1 BLUE	1	12	€ 13,77
22241	3660447222419	4 BLACK	1	12	€ 13,77



MARKAL

DURA-INK® 15



Ideal for layout work and parts identification, the DURA-INK 15 permanent ink marker has a fine bullet tip for precise marking. The wear-resistant, fast-drying ink and durable tip and barrel makes this marker ideal for industrial environments.

ITEM NR	PRODUCT EAN13	COLOR	BOX	CASE	PRICE
96022	0048615960227	RED	12	72	€ 0,92
96023	0048615960234	BLACK	12	72	€ 0,92
96025	0048615960258	BLUE	12	72	€ 0,92
96026	0048615960265	GREEN	12	72	€ 0,92
96027	0048615960272	SILVER	12	48	€ 1,19

MARKAL

DURA-INK® 15 - DISPLAY

Display including 44 Dura-Ink® 15

ITEM NR	PRODUCT EAN13	CONTENT	COLOR	BOX	CASE	PRICE
199006	3660447400060	TOTAL 44 MARKERS :		1	1	€ 40,72
			8 X RED			
			20 X BLACK			
			8 X BLUE			
			4 X GREEN			
			4 X SILVER			



MARKERS DURA-INK

MARKAL

DURA-INK® 15 - RETAIL PACK

Pack containing 4 DURA-INK® 5 ink markers

ITEM NR	PRODUCT EAN13	COLOR	BOX	CASE	PRICE
22240	3660447222396	1 BLACK + 1 RED + 1 BLUE + 1 GREEN + 1 SILVER	1	12	€ 6,92
22239	3660447222402	5 BLACK	1	12	€ 6,71



MARKAL

DURA-INK® 20

The DURA-INK 20 retractable permanent ink marker uses a one-handed, push-button for easy opening and closing. The convenient capless feature makes it ideal for use in tight work spaces and eliminates mess or lost caps.

ITEM NR	PRODUCT EAN13	COLOR	BOX	CASE	PRICE
96575	0048615965758	BLACK	12	24	€ 2,76
96576	0048615965765	RED	12	24	€ 2,76



MARKAL

DURA-INK® 20 - DISPLAY

Display including 32 Dura-Ink® 20

ITEM NR	PRODUCT EAN13	CONTENT	COLOR	BOX	CASE	PRICE
199007	3660447400077	77 TOTAL 32 MARKERS :		1	1	€ 87,61
			12 X RED			
			20 X BLACK			



MARKAL

DURA-INK 20® - RETAIL PACK

Pack containing 3 DURA-INK® 20 ink markers

ITEM NR	PRODUCT EAN13	COLOR	BOX	CASE	PRICE
22251	3660447222518	3 BLACK	1	12	€ 9,83
22252	3660447222525	2 BLACK + 1RED	1	12	€ 9,83



MARKAL

DURA-INK® 25

The DURA-INK 25 permanent ink marker's large, chisel tip offers the flexibility of producing fine or broad marks on almost any surface. With an extra-large ink supply and metal barrel, this marker offers longer marking life and durability.

ITEM NR	PRODUCT EAN13	COLOR	BOX	CASE	PRICE
96222	0048615962221	RED	12	48	€ 2,75
96223	0048615962238	BLACK	12	48	€ 2,75



MARKERS DURA-INK

MARKAL

DURA-INK® 200

Ideal for equipment identification and signs, the DURA-INK 200 permanent ink marker uses an over-sized tip to create large, highly-visible marks.

ITEM NR	PRODUCT EAN13	COLOR	BOX	CASE	PRICE
96914	0048615969145	GREEN	12	24	€ 5,67
96915	0048615969152	BLUE	12	24	€ 5,67
96916	0048615969169	RED	12	24	€ 5,67
96917	0048615969176	BLACK	12	24	€ 5,67



MARKAL

DURA-INK® 55

For flexible, finer line marking, the DURA-INK 55 features a medium chisel tip to produce both fine and broad permanent marks. This economical, durable plastic barrel withstands tough industrial use.

ITEM NR	PRODUCT EAN13	COLOR	BOX	CASE	PRICE
96528	0048615965284	RED	12	48	€ 1,33
96529	0048615965291	BLACK	12	48	€ 1,33
96530	0048615965307	BLUE	12	48	€ 1,33
96531	0048615965314	GREEN	12	48	€ 1,33



MARKAL

DURA-INK® 55 - DISPLAY

Display including 25 Dura-Ink® 55

ITEM NR	PRODUCT EAN13	CONTENT	COLOR	BOX	CASE	PRICE
199008	3660447400084	TOTAL 25 MARKERS :		1	1	€ 34,91
			5 X RED			
			10 X BLACK			
			5 X BLUE			
			5 X GREEN			



MARKAL

DURA-INK 55® - RETAIL PACK

Pack containing 2 DURA-INK® 55 ink markers

ITEM NR	PRODUCT EAN13	COLOR	BOX	CASE	PRICE
22243	3660447222433	2 BLACK	1	12	€ 4,94
22245	3660447222457	1 BLACK + 1 BLUE	1	12	€ 4,75
22244	3660447222440	1 BLACK + 1 RED	1	12	€ 4,94
22246	3660447222464	1 BLACK + 1 GREEN	1	12	€ 4,75



MARKERS PAINT MARKER

MARKAL

DURA-INK 60® - RETAIL PACK

Pack containing 2 DURA-INK®60 ink markers

ITEM NR	PRODUCT EAN13	COLOR	BOX	CASE	PRICE
22247	3660447222471	2 BLACK	1	12	€ 5,38
22249	3660447222495	1 BLACK + 1 BLUE	1	12	€ 5,38



MARKAL

SL.100 - PAINT MARKER

SL.100 is a xylene-free, low-odor fast-drying liquid paint marker that provides long-lasting marks for almost any surface. The 15 opaque, bright colors are weather- and UV-resistant for excellent mark identification.



ITEM NR	PRODUCT EAN13	COLOR	BOX	CASE	PRICE
31240120	3660447100700	WHITE	12	48	€ 3,25
31240220	3660447100717	YELLOW	12	48	€ 3,25
31240320	3660447100724	RED	12	48	€ 3,25
31240420	3660447100731	BLUE	12	48	€ 3,25
31240520	3660447100748	GREEN	12	48	€ 3,25
31240620	3660447100755	BLACK	12	48	€ 3,25
31240720	3660447100762	ORANGE	12	48	€ 3,25

ITEM NR	PRODUCT EAN13	COLOR	BOX	CASE	PRICE
31240820	3660447100779	PURPLE	12	48	€ 3,25
31240920	3660447100786	GREY	12	48	€ 3,25
31241020	3660447100793	PINK	12	48	€ 3,25
31241120	3660447100809	BROWN	12	48	€ 3,25
31241220	3660447100816	LIGHT BLUE	12	48	€ 3,25
31241320	3660447100823	LIGHT GREEN	12	48	€ 3,25
31241520	3660447100847	SILVER	12	48	€ 3,25

MARKAL

SL.100 - DISPLAY

Display including 32 SL100

ITEM NR	PRODUCT EAN13	CONTENT	COLOR	BOX	CASE	PRICE
199001	3660447400008	TOTAL 32 MARKERS : 12 X WHITE - 8 X YELLOW - 3 X RED - 3 X BLUE - 3 X GREEN - 3 X BLACK		1	1	€ 107,79



MARKAL

SL.100 - RETAIL PACK

Pack containing 4 SL.100 liquid paint markers

ITEM NR	PRODUCT EAN13	COLOR	BOX	CASE	PRICE
22229	3660447222297	2 WHITE + 2 YELLOW	1	12	€ 15,42
22230	3660447222303	1 WHITE + 1 YELLOW + 1 RED + 1 BLUE	1	12	€ 15,42



MARKAL

VALVE ACTION® PAINT MARKER

Liquid paintmarker for general marking

ITEM NR	PRODUCT EAN13	COLOR	BOX	CASE	PRICE
96800	0048615968001	1 WHITE	12	48	€ 7,78
96801	0048615968018	1 YELLOW	12	48	€ 7,78
96802	0048615968025	1 RED	12	48	€ 7,78
96803	0048615968032	1 BLACK	12	48	€ 7,78
96805	0048615968056	1 BLUE	12	48	€ 7,78
96806	0048615968063	1 GREEN	12	48	€ 7,78



MARKERS QUICK STIK + PAINTSTIK

MARKAL

PRO-LINE® HP

Markal Pro-Line® HP valve-action liquid paint markers were developed for superior marking performance on oily and greasy surfaces.



ITEM NR	PRODUCT EAN13	COLOR	BOX	CASE	PRICE
22237	3660447222372	1 WHITE + 1 BLACK + 1 RED + 1BLUE	1	12	€ 16,64

MARKAL

QUIK STIK® MINI

The high-performance paint dries quickly to leave bold, permanent marks on most surfaces.



ITEM NR	PRODUCT EAN13	COLOR	BOX	CASE	PRICE
61126	0048615611266	WHITE	12	48	€ 4,38
61127	0048615611273	YELLOW	12	48	€ 4,38
61128	0048615611280	RED	12	48	€ 4,38
61129	0048615611297	BLACK	12	48	€ 4,38

MARKAL

QUIK STIK® MINI - DISPLAY

Display including 44 Quik Stik® Mini

ITEM NR	PRODUCT EAN13	CONTENT	COLOR	BOX	CASE	PRICE
199003	3660447400046	TOTAL 44 MARKERS :		1	1	€ 180,32
			12 X WHITE			
			12 X YELLOW			
			12 X RED			
			12 X BLACK			



MARKAL

QUIK STIK® MINI - RETAIL PACK

Pack containing 5 Quik Stik® Mini solid paint markers

ITEM NR	PRODUCT EAN13	COLOR	BOX	CASE	PRICE
22238	3660447222389	2 WHITE + 1 YELLOW + 1 RED + 1 BLACK	1	12	€ 19,46



MARKAL

B® PAINTSTIK® - ALL SURFACES

Ideal for temporary marking of glass and other non-porous surfaces, Zephyr solid paint crayon is wear-resistant for durable marking and can be wiped off with water



ITEM NR	PRODUCT EAN13	COLOR	BOX	CASE	PRICE
80220	0048615802206	WHITE	12	144	€ 2,15
80221	0048615802213	YELLOW	12	144	€ 2,15
80222	0048615802220	RED	12	144	€ 2,15
80223	0048615802237	BLACK	12	144	€ 2,15
80224	0048615802244	ORANGE	12	144	€ 2,15
80225	0048615802251	BLUE	12	144	€ 2,15
80226	0048615802268	GREEN	12	144	€ 2,15

MARKERS PAINTSTIK + STYLMARK

MARKAL

B® PAINTSTIK® - DISPLAY

Display including 25 B® Paintstik®

ITEM NR	PRODUCT EAN13	CONTENT	COLOR	BOX	CASE	PRICE
199012	3660447400114	TOTAL 25 MARKERS :		1	1	€ 49,36
			12 X WHITE			
			6 X YELLOW			
			2 X RED			
			2 X BLUE			
			2 X GREEN			
			1 X BLACK			



MARKAL

B® PAINTSTIK® - RETAIL PACK

Pack containing 3 B Paintstik® solid paint crayons

ITEM NR	PRODUCT EAN13	COLOR	BOX	CASE	PRICE
22254	3660447222549	1 YELLOW + 1 BLACK + 1 RED	1	12	€ 8,19
22255	3660447222556	1 GREEN + 1 BLUE + 1 ORANGE	1	12	€ 8,19



MARKAL

STYLMARK - ALL SURFACES

Markal Stylmark is a metal-ball tip marker for marking most surfaces. The aluminium squeeze tube and thick paint makes it suitable for rough, vertical and overhead surfaces with excellent adhesion on oily and wet surfaces. Xylene-free paint reduces user health risks

ITEM NR	PRODUCT EAN13	TIP SIZE	COLOR	BOX	CASE	PRICE
96652	0048615966526	3 MM	WHITE	1	48	€ 3,49
96653	0048615966533	3 MM	YELLOW	1	48	€ 3,49
96654	0048615966540	3 MM	RED	1	48	€ 3,49
96655	0048615966557	3 MM	BLACK	1	48	€ 3,49
96657	0048615966571	3 MM	BLUE	1	48	€ 3,49
96658	0048615966588	3 MM	GREEN	1	48	€ 3,49
96656	0048615966564	3 MM	ORANGE	1	48	€ 3,49
96660	0048615966601	3 MM	PURPLE	1	48	€ 3,49
96662	0048615966625	3 MM	GREY	1	48	€ 3,49
96659	0048615966595	3 MM	PINK	1	48	€ 3,49
96661	0048615966618	3 MM	BROWN	1	48	€ 3,49



MARKAL

FM120 - INDUSTRIAL CRAYON

General purpose industrial crayon

ITEM NR	PRODUCT EAN13	CONTENT	COLOR	BOX	CASE	PRICE
44010100	13660447100295	TOTAL 12 MARKERS :	WHITE	12	72	€ 8,11
44010200	13660447100301		YELLOW	12	72	€ 8,11
44010300	13660447100318		RED	12	72	€ 8,11
44010400	13660447100325		BLUE	12	72	€ 8,11
44010500	13660447100332		GREEN	12	72	€ 8,11
44010600	13660447100349		BLACK	12	72	€ 8,11



MARKERS PRO-LINE® - SL.250 - PRO-WASH - WELDERS PENCILS

MARKAL

PRO-LINE® WP - WET SURFACES

The PRO-LINE WP is a liquid paint marker engineered for enhanced marking performance and adhesion on wet surfaces. The fast-drying formula resists spreading and running when in contact with water or water-based fluids to leave a bright, permanent mark.

ITEM NR	PRODUCT EAN13	COLOR	BOX	CASE	PRICE
96930	0048615969305	WHITE	12	48	€ 3,73
96931	0048615969312	YELLOW	12	48	€ 3,73
96932	0048615969329	RED	12	48	€ 3,73
96933	0048615969336	BLACK	12	48	€ 3,73
96934	0048615969343	BLUE	12	48	€ 3,73



MARKAL

SL.250 – STAINLESS STEEL

The PRO-LINE WP is a liquid paint marker engineered for enhanced marking performance and adhesion on wet surfaces. The fast-drying formula resists spreading and running when in contact with water or water-based fluids to leave a bright, permanent mark.

ITEM NR	PRODUCT EAN13	COLOR	BOX	CASE	PRICE
31200129		WHITE	12	48	€ 6,93
31200229		YELLOW	12	48	€ 6,93
31200329		RED	12	48	€ 6,93
31200429		BLUE	12	48	€ 6,93
31200529		GREEN	12	48	€ 6,93
31200629		BLACK	12	48	€ 6,93



MARKAL

PRO-WASH® W

PRO-WASH W and D are removable liquid paint markers that dry fast and can be quickly and easily washed off of any non-porous surfaces without ghosting or leaving a residue.

ITEM NR	PRODUCT EAN13	COLOR	BOX	CASE	PRICE
97030	0048615970301	WHITE	12	48	€ 3,99
97031	0048615970318	YELLOW	12	48	€ 3,99
97032	0048615970325	RED	12	48	€ 3,99
97033	0048615970332	BLACK	12	48	€ 3,99
97035	0048615970356	BLUE	12	48	€ 3,99
97036	0048615970363	GREEN	12	48	€ 3,99



MARKAL

WELDERS PENCILS – RETAIL PACK

Markal Silver-Streak and Red-Riter welders pencils make torch-resistant marks that will not burn or rub off like soapstone. Ideal for fine line marking during metal layout and fabrication, these highly visible marks illuminate when cutting or welding. Sold in pack of 12.

ITEM NR	PRODUCT EAN13	COLOR	BOX	CASE	PRICE
22219	3660447222198	2 SILVER-STREAK, 1 RED RITER	1	12	€ 6,46
22220	3660447222204	3 SILVER-STREAK	1	12	€ 6,46



PENCILS

DIGGERS
tools

DIG425

€ 6,57

Univesel Pencils
12 pieces, for Wood, Metal and Stone.
Ø 4 mm

EAN 5425009851425



DIGGERS
tools

DIG418

€ 1,82

Univesel Pencils
3 pieces for Wood, Metal and Stone.
Ø 4 mm

EAN 5425009851418



DIGGERS
tools

DIG371

€ 2,28

Carpenter pencils
3 pieces, Red, for Wood
240 x 5.0 x 2,0 mm, HB

EAN 5425009851371



DIGGERS
tools

DIG395

€ 2,93

Masonry pencils
3 pieces, Green, for Wood, Metal and Stone.
240 x 5.0 x 2,0 mm, 7H

EAN 5425009851395



DIGGERS
tools

DIG388

€ 8,19

Carpenter pencils
12 pieces, Red, for wood.
240 x 5.0 x 2,0 mm

EAN 5425009851388



DIGGERS
tools

DIG401

€ 9,75

Maconry pencils
12 pieces, Green, for Wood, Metal and Stone.
240 x 5.0 x 2,0 mm

EAN 5425009851401



PLUMBING

DIGGERS
tools

DLN119: DRAIN CLEANER 5 M

€ 12,48

Cleaner for use with Clearing Sink; Bath & Shower Waste Pipes

EAN: 5425009851272



DIGGERS
tools

DLN121: DRAIN CLEANER 10 M

€ 25,54

Cleaner for use with Clearing Sink; Bath & Shower Waste Pipes

EAN: 5425009851289



DIGGERS
tools

DLN120: DRAIN CLEANER

€ 9,84

Cleaner for use with Clearing Sink; Bath & Shower Waste Pipes.
Length 4m

EAN: 5425009851296



DIGGERS
tools

DLN116: WOODEN DRAIN CLEANER

€ 2,78

140mm rubber sink drain cleaner with 22 mm thick wooden handle.
Diameter 16 mm

EAN: 5425009851302



DIGGERS
tools

DLN117: SUCTION PUMP

€ 6,48

Suction pressure cleaner according to the air pump principle with water pressure. Clears blockages in drains, sinks, showers, bathtubs, etc.
Versatile, with swiveling suction cup.

EAN: 5425009851319





SOLDERING TORCHES

ROTHENBERGER
INDUSTRIAL

SOLDERING IRON

Heating time: approximately 2 minutes. Softgrip plastic handle
Nickel-plated copper tips straight / sharp and angled, flat

- VA heater element pipe with heat shield
- Connection cable (rubber) – 1.5 m
- Equipment support



PRODUCT	ART.-NO	PRODUCT EAN13	Ø	PRICE
40 WATT	35952	4004625359525	5.0 MM	€13,69
60 WATT	35953	4004625359532	5.8 MM	€14,14
80 WATT	35954	4004625359549	7.0 MM	€17,30
100 WATT	35959	4004625359594	8.0 MM	€17,55

SOLDERING GUN 100 W

€ 37,46

The soldering gun promises fast, accurate and reliable soldering
Soldering tip temperature: 510°C. Heating time: approximately 6 seconds. Rated, voltage: 230 – 240 V.

Art.-No: 35957

EAN 4004625359570



PROFESSIONAL SOLDERING IRON SET

€ 34,91

The perfect set for soldering in a plastic case
Rated voltage: 230 V/50 Hz. Soldering tip temperature: 25 W – 420°C,
80 W – 550°C. Heating time approximately 2 minutes.

Art.-No: 35060

EAN: 4004625022634



DIGITAL SOLDERING STATION

€ 107,80

Digital soldering station for universal use.
Temperature adjustable 200 450 °C.
Nominal voltage : 230 V. Temperature indication for optimal soldering work.
Ergonomic soldering iron with soft grip and replaceable soldering tips stable soldering iron stand with cleaning sponge, 230V ~ 50Hz / 48W

Art.-No: 1500003259

EAN : 4004625506936



WOOD MARKING SET

€ 31,80

The ideal set for the painting and refining of wooden objects and furniture
Professional handling for a creative pastime
Rated voltage: 230 – 240 V. 50 Hz

Art.-No: 30991

EAN: 4004625309919



SOLDERING IRON SET 30W

€ 32,53

The professional set for soldering
Soldering tip temperature: 300°C. Heating time: approximately 3 – 5 min. Nominal voltage: 230 – 240 V

Art.-No: 1500000041

EAN: 4004625368596



RO PEN 130

€ 26,19

The small, handy gas holder for delicate soldering work
Working temperature: approximately 450°C – 600°C

Art.-No: 35115

EAN: 4004625015124



HELPING HAND

€ 19,79

Practical bracelet : our helping craft is really like a third hand.
Each holder comes with a magnifying glass, two alligator clips and a holder for a soldering iron. This tool is ideal for work requiring a high level of precision

Art.-No: 1500002883

EAN: 4004625467916



SOLDERING TORCHES

HOT PACK SET - 2 PIECES € 31,01

The perfect soldering set for beginners
Working temperature: 650°C, Working time: 2.5 hours
1x soldering torch – 2x multigas 300 cartridges

Art.-No: 18078

EAN: 4004625180785



ROOFING SET WITH REGULATOR € 80,53

Ideal for working outdoors in all weathers
Flame temperature: approxima
Working temperature: up to 80l

Art.-No: 35498

EAN: 4004625354988



ROFLAME ECONOMY € 20,41

Rothenberger Industrial Roflame Economy
soldering torch soldering torch bunsen torch
soldering gas gas torch

Art.-No: 35912

EAN: 4004625053492



MINI TORCH SET € 42,61

Small, compact and handy
soldering cartridge
Working temperature: 650°C
Working time: approximately 1.5 h | Point burner: 14 mm

Art.-No: 35503

EAN: 4004625355039



ROFLAME PREMIUM € 27,05

The high quality soldering torch for
various soldering works
Working temperature: 650°C
Gas leading part made from brass

Art.-No: 35930

EAN: 4004625359303



ROFLAME PREMIUM PIEZO € 50,77

The high quality soldering torch for
soldering with piezo ignition
Working temperature: 650°C
Gas leading parts made from brass

Art.-No: 35931

EAN: 4004625359310



UNIVERSAL HOT FIRE € 61,37

Industrial-High Quality Flambier Burner, Can Work Overhead Fully
Adjustable Flame Up to 1300 Degrees Refillable Red. 1300 degree
flame temperature: tank capacity (44 ml) for a burning time of
approx. 60 minutes

Art.-No: 1500002990

EAN: 4004625470190



ROFIRE PIEZO 1950 € 51,21

The proven high-performance
soldering instrument for the handyman and
professionals with piezo ignition system
Working temperature: 750°C, Burner: 22 mm,
Gas leading parts made from brass
With multigas 300

Art.-No: 35555



SOLDERING TORCHES - GAS WELDING RODS

ROFIRE 1800 CC CARTRIDGE TORCH € 42,54

The proven high-performance soldering instrument for the handyman and professional. Working temperature: 710°C. Burner: 22 mm. Gas leading parts made from brass

Art.-No: 35501

EAN: 4004625355015



POWER MAPP € 89,15

The professional high performance soldering instrument for fast and safe working
Working temperature: approximately 1250°C

Art.-No: 030813E

EAN: 4004625052907



PROPANE SOLDERING SET 1800 € 56,28

Hose soldering device for beginners and advanced
Working temperature: 750°C. Burner unit made of brass

Art.-No: 30801

EAN: 4004625308011

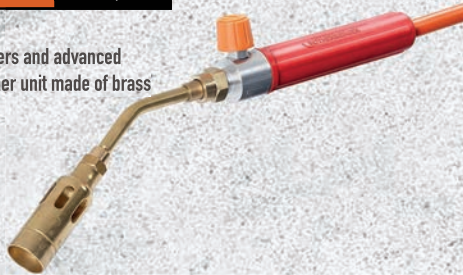

TURBO SOLDERING AND BRAZING SET 2000C° € 157,06

The high-performance turbo-soldering instrument with universal equipment in a complete set
Flame temperature: 2000°C. Working temperature: 800°C. Gas leading parts made out of brass

Art.-No: 30900

EAN: 4004625309001



ROLOT 601

Nickel silver brazing rods
Metallic joints, Iron, steel, copper, nickel, cast steel and non-ferrous metals

Art.-No: 35600 - Ø 2 mm + length 333 mm - 5 pieces Price € 19,06

EAN: 4004625048658

Art.-No: 35601 - Ø 2 mm + length 333 mm - 20 pieces (100 grams): Price € 6,73

EAN: 4004625356012



ROLOT 602

Brass welding and brazing rods
Metallic joints, Iron, steel, copper, nickel, cast steel and non-ferrous metals

Art.-No: 35602 - Ø 2,5 mm + length 333 mm
8 pieces (100 grams)

EAN: 4004625356029



ROLOT 603

Brass welding and brazing rods
Metallic joints, Iron, steel, copper, nickel, cast steel and non-ferrous metals

Art.-No: 35603 - Ø 1,5 mm + length 333 mm 8 pieces (100 grams): Price € 5,98

EAN: 4004625356036

Art.-No: 35803 - Ø 2 mm + length 500 mm 8 pieces: Price € 7,19

EAN: 44004625047941



ROLOT 604

Aluminium brazing and welding rods
Metallic joints, Aluminium brazing

Art.-No: 35604 - Ø 3 mm + length 333 mm (100 grams)

EAN: 4004625356043



GAS WELDING RODS - SOLDER WIRE

ROTHENBERGER
INDUSTRIAL

GAS WELDING RODS 605

Autogenous welding rod copper plates. Welding. For mechanical engineering boiler construction, pipe work and vehicle construction



Art.-No: 35605 - Ø 1,5 mm + length 333 mm - 20 pieces: Price € 3,08

EAN: 4004625356050

Art.-No: 31251 - Ø 2 mm + length 500 mm - 10 pieces: Price € 4,22

EAN: 4004625312513

Art.-No: 31252 - Ø 3 mm + length 500 mm - 10 pieces: Price € 5,24

EAN: 4004625312520

ROTHENBERGER
INDUSTRIAL

GAS WELDING RODS 607

Brazing rods for copper joints
Pipe installations gutters, general metal work with copper



Art.-No: 35607 - Ø 2 mm + length 333 mm
5 pieces - (100 grams): Price € 5,18

EAN: 4004625356074

Art.-No: 35707 - Ø 2 mm + length 333 mm
25 pieces - (250 grams) : Price € 21,55

EAN: 4004625357071

Art.-No : 35807 - Ø 2 mm + length 500 mm
25 pieces - (250 grams) : Price € 23,93

EAN: 4004625047958

ROTHENBERGER
INDUSTRIAL

ROLOT 610

Special silver solder 6 %. Gas installations

Art.-No : 35817 - Ø 2 mm + length 330 mm
5 pieces - (100 grams): Price € 22,50

EAN: 4004625047972

Art.-No: 35818 - Ø 2 mm + length 500 mm
8 pieces - (100 grams): Price € 54,46

EAN: 4004625358184



ROTHENBERGER
INDUSTRIAL

ROLOT 606

€ 20,44

Silver brazing rod 45 %
Pipe installations gutters,
general metal work with copper



Art.-No: 35606 - Ø 1,5 mm + length 333 mm
1 piece - (25 grams)

EAN: 4004625356067

ROTHENBERGER
INDUSTRIAL

ROLOT 609

Special silver solder 6 %
Pipe installations, Metallic joints, Iron,
steel and cast steel, non-ferrous metals



Art.-No: 35609 - Ø 1,5 mm + length 333 mm
2 pieces : Price € 12,27

EAN: 4004625356098

Art.-No: 35809 - Ø 1,5 mm + length 500 mm
4 pieces: Price € 29,51

EAN: 4004625047965

ROTHENBERGER
INDUSTRIAL

ROLOT 611

Soft soldering rod for general installation work

Art.-No : 1000002361 - Ø 6,7 mm + length 300 mm -
1 piece: Price € 8,97

EAN: 4004625468937

Art.-No: 1000002362 - Ø 10 mm + length 400 mm - 3 pieces
(650 grams): Price € 110,81

EAN: 4004625468920



SOLDER WIRE - FLUX PASTE

FITTINGS SOLDER 3

Quality solder to DIN EN ISO 9453
Heating installations, Drinking water installations

Art.-No: 045253E - 50 gr - Ø 3 mm: Price € 8,04

EAN: 4004625051597

Art.-No: 045255E - 250 gr - Ø 3 mm.: Price € 39,04

EAN: 4004625452554

Art.-No: 045256E - 100 gr - Ø 3 mm.: Price € 12,27

EAN: 4004625452561



LEAD-FREE STANDARDSOLDER

Elektronische Bauteile: Leiterplatten, Kabel / Litzen / Drähte

Art.-No : 1000002353 - 30 gr - Ø 2 mm: Price € 11,03

EAN: 4004625468821

Art.-No: 1000002354 - 70 gr - Ø 2 mm: Price € 16,51

EAN: 4004625468845



LEAD-FREE ELECTRONIC SOLDER

Electronic components: printed circuit boards,
cables, strands, wires

Art.-No: 1000002348 - 30 gr - Ø 1 mm: Price € 10,24

EAN: 4004625468746

Art.-No: 1000002349 - 70 gr - Ø 1 mm: Price € 16,51

EAN: 4004625468760



LEAD-FREE ELECTRONIC SOLDER

Elektronische Bauteile: Leiterplatten, Kabel / Litzen / Drähte

Art.-No: 1000002350 - 30 gr - Ø 1.5 mm: Price € 12,11

EAN: 4004625468777

Art.-No: 1000002351 - 70 gr - Ø 1.5 mm: Price € 19,61

EAN: 4004625468784



LEAD FREE SOFT SOLDER

€ 20,87

Lead-free soldered electronic components:
Circuit boards, cables / strands / wires

Art.-No: 1000001887 - 100 gr - Ø 1 mm:

EAN: 4004625413784



FITTINGS PASTE SOLDER

For soldering of heating and drinking water pipes, 35 ml

Art.-No: 045225E: Price € 28,14

EAN: 4004625452257

Art.-No: 045226E: Price € 11,99

EAN: 4004625452264



SOFT SOLDER FLUX

For soldering of copper tubes in the cold
and hot water installation.

Art.-No: 045266E - 35 ml: Price € 4,60

EAN: 4004625452660

Art.-No: 1000000242 - 120 ml: Price € 6,58

EAN: 4004625374795



SOLDINGER FLUID

€ 3,71

General soldering of iron, steel, brass, copper, lead and tin, 24 ml

Art.-No: 035719E

EAN: 4004625357194



ACCESSORIES - GAS WELDING TORCHES

BOTHENBERGER INDUSTRIAL

HOT PACK BURNER

€ 16,49

The power burner for gas cartridges with 7/16" - EU connection
Working temperature: 650°C. Brass burner

Art.-No: 520854E

EAN: 4004625046401



BOTHENBERGER INDUSTRIAL

COPPER SOLDERING IRON

€ 58,88

Weight: 250 g | Brass gas burner. Soldered joints of gutters and downpipes made of copper, galvanised steel and titanium zinc sheets up to 1.5 mm thick. Tinsmith works. Extension for all soldering equipment with propane handle M 14 x 1,6 3/8" L.

Art.-No: 35499

EAN: 4004625354995



BOTHENBERGER INDUSTRIAL

ROXY KIT PLUS

€ 230,19

Roxy Kit Plus
The Roxy Kit Plus is a universal gas welding and brazing torch for an ambitious handyman and a true professional

Art.-No: 35740

EAN: 4004625357408



BOTHENBERGER INDUSTRIAL

PROPANE HANDLE

€ 23,48

The ergonomic handle for hose soldering devices
Connection: M 14 x 1-G 3/8" L | Gas leading parts made from brass.
For gas soldering equipment with hose connection.

Art.-No: 030910E

EAN: 4004625309100



BOTHENBERGER INDUSTRIAL

GAS REGULATING VALVE

€ 18,23

To regulate the flow of gas for welding and soldering equipment

Art.-No: 035723E

EAN: 4004625357231



ARC WELDERS

BOHNERBERGER
INDUSTRIAL

ROWELDO 160

€ 199,68

Portable electrode welder – single phase with a fan and thermal protection. Rated voltage: 230 V / 50 Hz. Welding current control range: 55 – 160 A. Power fuse: 16 A. Open circuit voltage: 48 V. Insulation class: H. Protection class: IP21S. Average operating. For the welding of rod electrodes: 1.5 mm – max. 3.25 mm

Art.-No: 36015

EAN: 4004625360156



BOHNERBERGER
INDUSTRIAL

ROCORED WELDER 90

€ 394,27

Portable cored wire welding machine without gas protection. Rated voltage: 230 V / 50 Hz. Suitable for 0.6 mm – 0.9 mm cored wire. For the welding of cored wire. Without addition of protective gas

Art.-No: 1500000542

EAN: 4004625380710



BOHNERBERGER
INDUSTRIAL

ROWIN 80

€ 260,36

Powerful electrode welding machine with modern inverter technology. Connection: 1 phase, Input current: 14.3 A. Idle: 68 V. Power consumption: 11 A. Duty cycle: 62A / 22.5V = 100%; 80A / 23.2V = 100%. Fuse: 13 A. Nominal voltage: 230 V / 50 Hz. Max. Weldable electrodes: 1.6 – 2.5 mm. Insulation class: H. Degree of protection: IP21S. Weight: 4.6 kg

Art.-No: 1500002185

EAN: 4004625406045



BOHNERBERGER
INDUSTRIAL

ROWIN 140

€ 298,73

Powerful electrode welding machine with modern inverter technology. Connection: 1 phase, Input current: 23.8 A. Idle: 60 V. Power consumption: 14.1 A. Duty cycle: 77A / 23.1V = 100%; 99A / 24V = 60%; 130A / 25.2V = 35%. Validation: 16 A. Nominal voltage: 230 V / 50 Hz. Suitable for TIG welding. Max. Weldable Electrodes: 1.5 – 3.2 mm. Insulation class: H. Degree of protection: IP21S. Weight: 5 kg

Art.-No: 1500002184

EAN: 4004625406038



ELECTRODES

ROTHENBERGER
INDUSTRIAL

ROWELD 708

€ 2,96

Arc welding, assembly or repair of iron and low-alloy steel. Current in Amps 30 – 50.

Art.-No 35708 - Ø 1.5 mm + length 333 mm - 10 peices

EAN: 4004625357088



ROTHENBERGER
INDUSTRIAL

ROWELD 710

Arc welding, assembly or repair of iron and low-alloy steel. Current in Amps 60 – 100

Art.-No : 35710 - Ø 2,5 mm + length 350 mm - 8 pieces: Price € 3,54

EAN: 4004625357101

Art.-No : 31223 - Ø 2,5 mm + length 350 mm - 1kg - 50 pieces: Price € 18,20

EAN: 4004625312230

Art.-No : 31224 - Ø 2,5 mm + length 350 mm - 2,5 kg - 125 pieces: Price € 38,95

EAN: 4004625312247



ROTHENBERGER
INDUSTRIAL

ROWELD 712

€ 4,55

Arc welding, assembly or repair of iron and low-alloy steel. Current in Amps 100 – 160

Art.-No : 35704 - Ø 4 mm + length 350 mm - 5 pieces

EAN: 4004625049952



ROTHENBERGER
INDUSTRIAL

ROWELD 712 AL

€ 9,23

Arc welding, assembly or repair of aluminium parts: Motor blocks, cylinder heads, canisters, tanks, containers, skips etc. Current in Amps 50 – 80

Art.-No : 35702 - Ø 2,5 mm + length 350 mm - 10 pieces

EAN: 4004625049969



ROTHENBERGER
INDUSTRIAL

ROWELD 709

Arc welding, assembly or repair of iron and low-alloy steel. Current in Amps 40 – 70
Material thickness: 1.5 – 4 mm

Art.-No : 35709 - Ø 2 mm + length 300 mm - 10 pieces: Price € 3,17

EAN: 4004625357095

Art.-No : 31221 - Ø 2 mm + length 300 mm - 1kg - 80 pieces: Price € 22,83

EAN: 4004625312216

Art.-No : 31222 - Ø 2 mm + length 350 mm - 2,5 kg - 195 pieces: Price € 43,62

EAN: 4004625312223



ROTHENBERGER
INDUSTRIAL

ROWELD 711

Arc welding, assembly or repair of iron and low-alloy steel. Current in Amps 85 – 140

Art.-No : 35711 - Ø 3,25 mm + length 350 mm - 5 pieces: Price € 3,74

EAN: 4004625357118

Art.-No : 31225 - Ø 3,25 mm + length 350 mm - 1kg - 35 pieces: Price € 14,72

EAN: 4004625312254

Art.-No : 31226 - Ø 3,25 mm + length 350 mm - 2,5 kg - 87 pieces: Price € 31,80

EAN: 4004625312261



ROTHENBERGER
INDUSTRIAL

ROWELD 712 V2A

€ 10,76

Arc welding, assembly or repair of stainless steel parts: Chemical and petrochemical applications, marine applications, heat exchangers and installations. Current in Amps 50 – 70

Art.-No : 31243 - Ø 2 mm + length 300 mm - 10 pieces

EAN: 4004625312438



ROTHENBERGER
INDUSTRIAL

ROWELD 712 NICU

€ 32,97

Arc welding parts made of cast iron or cast steel, assembly/repair of motor blocks, machine parts, transmissions, pumps, valves and armatures etc. Current in Amps 50 – 90.

Art.-No : 35730 - Ø 2,5 mm + length 300 mm - 10 Pieces

EAN: 4004625357309



WELDING WIRES

ROTHENBERGER
INDUSTRIAL

MIG WELDING WIRE- 0,6 MM € 14,55

Copper plated steel welding wire.
Iron / steel use with a MIG/MAG welder

Art.-No: 31231 - 1 Kg - Ø 0.6 mm

EAN: 4004625312315



ROTHENBERGER
INDUSTRIAL

MIG WELDING WIRE - 0.8 MM € 11,77

Copper plated steel welding wire.
Iron / steel use with a MIG/MAG welder

Art.-No: 31232 - 1 Kg - Ø 0.8 mm

EAN: 4004625312322



ROTHENBERGER
INDUSTRIAL

MIG WELDING WIRE 0,6 MM € 62,84

Copper plated steel welding wire.
Iron / steel use with a MIG/MAG welder

Art.-No: 31233 - 5 Kg - Ø 0.6 mm

EAN: 4004625312339



ROTHENBERGER
INDUSTRIAL

MIG WELDING WIRE 0,8 MM € 51,90

Copper plated steel welding wire.
Iron / steel use with a MIG/MAG welder

Art.-No: 31234 - 5 Kg - Ø 0.8 mm

EAN: 4004625312346



ROTHENBERGER
INDUSTRIAL

STAINLESS STEEL WELDING WIRE € 45,74

Stainless steel use with a MIG/MAG welder

Art.-No: 31235 - 1 Kg - Ø 0.8 mm

EAN: 4004625312353



ROTHENBERGER
INDUSTRIAL

ALUMINIUM WELDING WIRE € 29,12

Aluminium use with a MIG/MAG welder

Art.-No: 31236 - 0,5 Kg - Ø 1 mm

EAN: 4004625312360



WELDING ACCESSORIES

ELECTRODE HOLDER

Clamping to the right, left and to the front is possible
Suitable for all rod electrodes

Art.-No : 530209 - 200 A / M 8, up to 2.4 mm -
price: € 18,74

EAN: 4004625302095

Art.-No : 530210 - 300 A / M 8 | up to 3.2 mm
price: € 20,39

EAN: 4004625302101



M8 GAS NOZZLE CYLINDRICAL

Gas nozzle for protective gas burners type 10 with M8 thread
Material: Copper, nickel, Screwable, Thread: M 8
Supply of protective gas in MIG / MAG welding equipment

Art.-No : 530220 - (2 pieces) - cylindrical - price: € 8,98

EAN: 4004625302200

Art.-No : 530221 - (2 pieces) - conical - price: € 9,82

EAN: 4004625026748

Art.-No : 530226 - Cylindrical and Conical set (1 of each) - price: € 14,14

EAN: 4004625302262



CONTACT TIP

Contact tip for wire electrode Material: bare electrolytic copper.
For MIG / MAG equipment, 6 x Power nozzles

Art.-No : 530230 - M 5 - 0,6 x 18 mm - price: € 6,68

EAN: 4004625302309

Art.-No : 530231 - M 5 - 0,8 x 18 mm - price: € 6,44

EAN: 4004625302316

Art.-No : 530232 - M 6 - 0,6 x 25 mm - price: € 6,54

EAN: 4004625302323

Art.-No : 530233 - M 6 - 0,8 x 25 mm - price: € 6,54

EAN: 4004625302330

Art.-No : 1000002277 - M 6 - 0,9 x 25 mm - price: € 10,51

EAN: 4004625468029

Art.-No : 530234 - M 6 - 1,0 x 25 mm - price: € 6,54

EAN: 4004625302347



EARTH TERMINAL

Zinc plated, For M6 cable connections

Art.-No : 530211 - 150 A / M 6 - price: € 9,33

EAN: 4004625302118

Art.-No : 530212 - 200 A / M 8 - price: € 9,54

EAN: 4004625302125



15 PLUS GAS NOZZLE

Gas nozzle for protective gas burners type 15 with M10 thread
Material: Copper, nickel, For Ø 12 mm shafts, Thread: M 10, pluggable
Supply of protective gas in MIG / MAG welding equipment

Art.-No : 530222 - Cylindrical (2 pieces) - price: € 8,82

EAN: 4004625026755

Art.-No : 530223 - Conical (2 pieces) - price: € 9,73

EAN: 4004625302231

Art.-No : 530227 - Cylindrical and Conical set (1 of each) - price: € 10,87

EAN: 4004625302279



ANGLE MAGNET

€ 7,98

For the fixing and aligning of flat and round weldments
Fusing range: 30°, 45°, 60°, 75°, 90°

Art.-No : 530213 - 100 x 65 mm - price: € 13,41

EAN: 4004625302132

Art.-No : 530214 - 120 x 90 mm - price: € 16,22

EAN: 4004625302149



WIRE BRUSH

The perfect cleaner for coarse matters.
Cleaning of castings, cleaning of metal surfaces

Art.-No : 561351E - 3 rows - price: € 2,94

EAN: 4004625027677

Art.-No : 561352E - 4 rows - price: € 4,04

EAN: 4004625027684

BOTHENBERGER
INDUSTRIAL



SAFETY TOP LIGHTER

€ 4,61

The safe gas lighter for all soldering and welding equipment
The fuel gas is ignited safely in the pan by direct action of the spark.
Flint replaceable. Safe gas ignition

Art.-No : 032093E

EAN: 4004625320938

BOTHENBERGER
INDUSTRIAL



CHIPPING HAMMER

€ 10,09

Made of metal .With 2 punch ends (flat / pointed), Weight: 430 g

Art.-No : 530215

EAN: 4004625302156

BOTHENBERGER
INDUSTRIAL



PRESSURE REDUCER

€ 116,37

Pressure reducer with 2 manometers
Pressure flow can be adjusted manually with
2 manometers. Contents gauge:
0 - 315 bar. With shut-off valve and hose
connector. W 21.8 x 1. - G 1/4" R
or protective gas equipment
(CO2, argon and carbon acid)

Art.-No : 530217

EAN: 4004625302170

BOTHENBERGER
INDUSTRIAL



PRESSURE REDUCER

€ 68,47

Single-stage. Up to 130 bar test pressure with
safety gauge according to EN 562.
Contents gauge adjustable from 0 to 6 bar.
Input: M 10 x 1 right . Output: G 1/4" R
with hose nozzle

Art.-No : 530218

EAN: 4004625302187

BOTHENBERGER
INDUSTRIAL



OXYGEN PRESSURE REDUCER

€ 48,70

Bottle contents: 110 bar. Input: M.10 x 1. Output: G 1/4" R
Fits oxygen disposable bottles with 10 x 1 thread

Art.-No : 1500000465

EAN: 4004625379240

BOTHENBERGER
INDUSTRIAL



OXYGEN PRESSURE REDUCER

€ 107,76

Bottle contents: 200 bar. Working pressure: 0 - 10 bar.
Input: G 3/4" R. Output: G 1/4" R
Suitable for oxygen-returnable bottles:
Roxy 400L, Roxy Universal and Standard t
hree gas equipment

Art.-No : 35634

EAN: 4004625001240

BOTHENBERGER
INDUSTRIAL



WELDING ACCESSORIES

BOTHENBERGER
INDUSTRIAL

HOSE PACKAGE FOR ROXY PLUS 120 L

€ 14,56

The hose pack for autogenous welding devices in the Roxy Series With integrated gas non-return function. Oxygen pressure reducer (integrated non-return function). Includes Grip with regulating valves (connection: 14 x 1). Oxygen hose connection G 1/4" R. Gas hose connection M 10 x 1. For autogenous welding equipment from the Roxy Series with oxygen disposable bottles.



Art.-No : 32163

Hose length: 1.5 m each

EAN: 4004625333006

BOTHENBERGER
INDUSTRIAL

WELDING PROTECTION GOGGLES DIN5

€ 6,89

To protect the conjunctiva from burns. Plastic frame with adjustable temples and fold-out side protection. Interchangeable protective glasses. Robust safety glasses with traditional visors. Brazing and soldering. Autogenous welding. Flame cutting



Art.-No : 035621E - DIN 5:

Glass Size: Ø 50 mm

EAN: 4004625356210

BOTHENBERGER
INDUSTRIAL

ROPROTECT PROTECTIVE HAND SHIELD

€ 14,39

Provides protection during welding. Simple housing made from fire-resistant material with handle. Standardised recording of light stabilisers and glass filters. For arc welding process (E, MIG, MAG, TIG)

Art.-No : 530201 - Glass size: 90 x 110 mm

EAN: 4004625027738



BOTHENBERGER
INDUSTRIAL

DOUBLE OUTLET VALVE PROPANE / BUTANE

€ 22,46

Usable with all regulators with connection 2 x 1/4" L. Operating 2 units with only one pressure reducer. High quality Material. Easily adjustable

Art.-No : 1500003364

EAN: 4004625521656



BOTHENBERGER
INDUSTRIAL

AUTOMATIC WELDING PROTECTIVE HEAD SHIELD

€ 188,08

The surefire protection during welding – Recommended for DIY and professionals. Very solid housing made of fire resistant plastic, ergonomically shaped. Ambidextrous works by fastening device on the head. Infinitely adjustable headband with automatically darkened active welding glass. Passive DIN 4, active DIN 9 – 13, infinitely adjustable from the outside. Powered by solar cells. Sensitive adjustment. Temperature resistance up to 130°C. Approved according to EN 175 and EN 379

Art.-No : 1500000171

EAN: 4004625371312



PRESCRIPTION GLASS

€ 3,82

Replacement glass for ROTHENBERGER Industrial welding protective screens or the protection of welding protection glasses

Art.-No : 530204 - Glass size: 90 x 110 mm

EAN: 4004625302040



PROTECTIVE GLOVES

€ 8,76

Quality gloves for optimum heat protection
5-Finger. Size 10 with cuffs. Made from split leather.
Protection for the hands during welding

Art.-No : 530216

EAN: 4004625302163



PROTECTIVE GLASS

Replacement glass for ROTHENBERGER Industrial welding protective screens. 2 glasses.

Art.-No : 530205 - DIN 9: 90 x 110 mm - Price € 6,36

EAN: 4004625302057

Art.-No : 530206 - DIN 11: 90 x 110 mm - Price € 9,73

EAN: 4004625302064



WELDING PROTECTION APRON

€ 38,74

Quality split leather welding apron, 800 x 1000 mm.
Protection of the upper body during welding

Art.-No : 1500002786

EAN: 4004625466001



INDUSTRIAL GASES - FUEL GAS

ROTHENBERGER
INDUSTRIAL

C200 SUPERGAS

The C200 Supergas piercing cartridge is universally applicable for devices with a corresponding receiving device. High purity butane gas mixture. This cartridge may be used with any device category immediate butane pressure according to EN 521. Blow lamps, Bunsen burner, Scout camp stove, Scout camping lamp



Art.-No : 1500000924 - 190 g / 330 ml - price: € 3,24

EAN: 4004625387269

ROTHENBERGER
INDUSTRIAL

MAXIGAS 400

€ 7,63

High performance, welding, cutting and brazing gas. Screw cartridge, Connection: 7/16" EU, Gas mix: 21.5 % Acetone, 56 % N-Butane Isobutane, 1.5 % Pentane, 21 % Propane. Gas welding, Brazing 600 ml / 352 g



Art.-No : 35570

EAN: 4004625355701

ROTHENBERGER
INDUSTRIAL

MINIGAS 100

€ 4,49

Mini tinplate screwable cartridges. Connection: 7/16" EU, Gas mix: 30 % Propane, 70 % Butane, 150 ml / 85 g



Art.-No : 35504

EAN: 4004625355046

ROTHENBERGER
INDUSTRIAL

TOPGAS 220

€ 8,47

Tinplate screwable cartridges. Connection: 7/16" EU, Gas mix: 30 % Propane, 70 % Butane High stability for the operation of gas appliances in camping, picnics and various laboratory burners. 370 ml / 220 g



Art.-No : 35201

EAN: 4021572075728

ROTHENBERGER
INDUSTRIAL

MULTIGAS 300

€ 5,67

Tinplate screwable cartridges. Connection: 7/16" EU, Gas mix: 30 % Propane, 70 % Butane? 600 ml / 338 g

Art.-No : 35510

EAN: 4004625355107



ROTHENBERGER
INDUSTRIAL

ROFILL SUPER 100

€ 2,44

Aluminium gas refill cartridge. Gas mix: 25 % Propane, 75 % Butane Various nozzle adapter caps. High purity for the operation of micro soldering torches. 100 ml / 56 g

Art.-No : 35840

EAN: 4004625358405



ROTHENBERGER
INDUSTRIAL

MAPP GAS

€ 23,48

ROTHENBERGER special gas mixture. Screw cartridge, Connection: 7/16" EU | Gas mix: Butane - Propylene Welding, Brazing. Allows very high working temperatures Constant gas pressure at low ambient temperatures: 750 ml / 411 g

Art.-No : 035551-A

EAN: 4004625355510



ROTHENBERGER
INDUSTRIAL

GAS CARTRIDGE ROBUTANE 220 G / 393 ML

€ 3,09

Complex mixture in valve cartridge with n-butane as fuel for camping cookers and other powered appliances used in caravans or motor homes. The RoButan cartridge has a so-called "bayonet lock", a mechanical connection that can be quickly made and released again Applications: Weed burner, Soft Soldering, Grilling etc.

Art.-No : 1500003504

EAN: 400462531136



INDUSTRIAL GASES - PROTECTIVE GAS

ROTHENBERGER
INDUSTRIAL

UNIVERSAL REFILL CARTRIDGE € 2,43

Aluminium gas refill cartridge, Gas mixture: 84 % butane, 16 % propane. Various nozzle adapters in cap. For the operation of gas lighters and small soldering devices

Art.-No : 1500002897

EAN: 4004625468692



ROTHENBERGER
INDUSTRIAL

ARGON € 29,51

Protective gas steel single use bottle. Connection: M 10 x 1. To protect the molten bath during MIG welding. 950 ml. Full pressure: 60 bar

Art.-No : 35775

EAN: 4004625357750



ROTHENBERGER
INDUSTRIAL

CARBON DIOXIDE (CO2) € 28,32

Protective gas steel single use bottle. Connection: M 10 x 1. To protect the molten bath during MAG welding. 950 ml. Full pressure: 36 bar

Art.-No : 35776

EAN: 4004625357767



ROTHENBERGER
INDUSTRIAL

OXYGEN (O2) SINGLE USE BOTTLE € 33,67

Steel single use bottle. Connection: M 10 x 1 sx. Not suitable for medical purposes. Welding in combination with fuel gas. Brazing in combination with fuel gas. 930 ml / 110 bar full pressure

Art.-No : 35741

EAN: 4004625357415



ROTHENBERGER
INDUSTRIAL

GAS BOTTLE TROLLEY € 116,25

For effortless and safe transport of all kinds of gas bottles. Sturdy wheels with solid rubber tires. With practical holders for gas hose and burner. Adjustable chain to secure the bottle.

Art.-No : 1500003367

EAN: 4004625521793



FLAMING DEVICES

ROTHENBERGER INDUSTRIAL

WEED BURNER PREMIUM

€ 63,90

Very light with total weight of only 800g. Total length 88 cm for comfortable work without bending over. Up to 2 times faster weed killing. Large area wide jet nozzle. Ergonomic two component handle (plastic rubber prevents slipping, Aluminium burner tube for a permanent use. Efficient thermal weed control, no chemistry. Piezo ignition. For terrace, yard and stairs, paved paths etc.. For warming up, thawing and flaming

Art.-No : 1500003247

EAN: 4004625506806



ROTHENBERGER INDUSTRIAL

ROMAXI PREMIUM

€ 74,03

The power burner for flaming and hot glue works
Flame temperature: up to 1060°C. Gas pressure: max. 4 bar, 8 kg/h. Flexing burner with 60 cm approx. 35° bend. Burner: Ø 57 mm
Scarifying of bitumen sheets. Warming, Singe, Sealing films. Tar work. Roof insulation. Concrete and masonry drying. Biological weed and moss removal

Art.-No : 030954E - 5.0 m propane gas hose

EAN: 004625309544



ROTHENBERGER INDUSTRIAL

ROMINI PREMIUM

€ 52,37

The power burner for flaming and hot glue works
Flame temperature: up to 1060°C. Gas pressure: max. 4 bar, 8 kg/h. Flexing burner with 60 cm approx. 35° bend. Burner: Ø 57 mm
Scarifying of bitumen sheets. Warming, Singe, Sealing films. Tar work. Roof insulation. Concrete and masonry drying. Biological weed and moss removal

Art.-No : 030961E - 2.0 m propane gas hose

EAN: 4004625309612



ROTHENBERGER INDUSTRIAL

UNIVERSAL BURNER

The proven universal burner for various flaming work
Flame temperature: 940°C. Thermal weed and moss eradication. Warming, Singe, Sealing of films

Art.-No : 30966 - Without gas - price: € 31,16

EAN: 4004625309667

Art.-No : 1000000189 - 1x Multigas 300 jumbo cartridges - price: € 39,72

EAN: 4004625373255



ROTHENBERGER INDUSTRIAL

ROMAXI PREMIUM PIEZO

€ 90,85

The power burner with piezo ignition for flaming and hot glue works. Piezo ignition, Flame temperature: up to 1060°C. Gas pressure: max. 4 bar, 8 kg/h. Short flexing burner with 57 mm, 60 cm long burning pipe. 35° bend. Scarifying of bitumen sheets. Warming, Singe, Sealing films. Tar work. Roof insulation. Concrete and masonry drying. Biological weed and moss removal

Art.-No : 030955E - 5.0 m propane gas hose

EAN: 4004625309551



ROTHENBERGER INDUSTRIAL

ROMAXI ECONOMY

The power burner for flaming and hot glue works in an economy version.
Flame temperature: up to 1060°C. Gas pressure: max. 4 bar, 8 kg/h. Burner flexing with 60 cm, 35° bend. Burner: Ø 57 mm. Scarifying of bitumen sheets. Warming, Singe, Sealing films. Tar work. Roof insulation. Concrete and masonry drying. Biological weed and moss removal

Art.-No : 030958E - 5.0 m propane gas hose - price: € 47,98

EAN: 4004625309582

Art.-No : 1500000930 - 5.0 m propane hose & propane constant regulator - price: € 66,70

EAN: 4004625388198



ROTHENBERGER INDUSTRIAL

WEED BURNER RS 220

€ 22,07

Complex mixture in valve cartridge with n-butane as fuel for camping cookers and other powered appliances used in caravans or motor homes. The RoButan cartridge has a so-called "bayonet lock", a mechanical connection that can be quickly made and released again.
Applications: Weed burner, Soft Soldering, Grilling etc.

Art.-No : 1500003637

EAN: 4004625534199



ROTHENBERGER INDUSTRIAL

TURBO PLUS

€ 48,16

The broad-beam universal burner with jumbo multi-gas giant for very good flaming results. Flame temperature: 940°C. Thermal weed and moss eradication. Warming, Singe, Sealing of films

Art.-No : 1000001250 - 1x Multigas Jumbo cartridge

EAN: 4004625396520



FLAMING DEVICES - ACCESSORIES

BOTHENBERGER INDUSTRIAL

PROPANE GAS LEAK PROTECTION € 15,89

Security element for the operation of gas appliances. 10 – 14 kg / h. 2 x G 3/8" L-DVGW checked. Usable together with propane regulators with G 3/8" L outlet. Mounting directly on the controller. Gas soldering equipment with hose lengths of over 5.0 m Required for commercial use.

Art.-No : 035925E - 1.5 – 4 bar

EAN: 4004625359259



BOTHENBERGER INDUSTRIAL

PROPANE REGULATOR € 45,97

0.5 – 4 bar. Infinitely adjustable | W 21.8 x 1 / 1/4" L-D max. 8 kg/h. DVGW-checked. Product coverage. For propane gas bottles 5 kg, 11 kg, 33 kg and gas soldering equipment with hose connection G 3/8" L

Art.-No : 032082E - 0.5 – 6 bar

EAN: 4004625014646

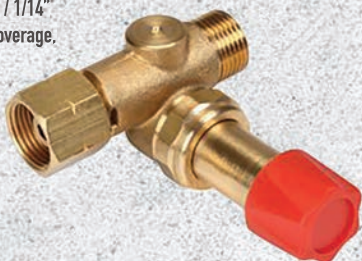

BOTHENBERGER INDUSTRIAL

PROPANE CONSTANT REGULATOR € 17,23

W 21.8 x 1/14" L – G 3/8" L-D max. 8 kg/h | DVGW-checked For propane gas bottles 5 kg, 11 kg, 33 kg and gas soldering equipment with hose connection G 3/8"

Art.-No : 030925E - 4 bar

EAN: 4004625309254



BOTHENBERGER INDUSTRIAL

PROPANE GAS HOSE LINE

Pressure: 2 MPa (20 bar). Ø 5 mm. Connection: 2 x G 3/8" L certified according EN 1327. Can be used in conjunction with double nipple (item 540255E) as an extension tube

Art.-No : 030927E - Length: 2.0 m - price: € 18,39

EAN: 4004625309278

Art.-No : 032201E - Length: 2.5 m - price: € 22,12

EAN: 4004625322017

Art.-No : 033310E - Length: 5 m - price: € 35,21

EAN: 4004625333105



BOTHENBERGER INDUSTRIAL

PROPANE REGULATOR € 23,48

0.5 – 4 bar | Infinitely adjustable, W 21.8 x 1/14" L-D max. 8 kg/h. DVGW-checked. Product coverage For propane gas bottles 5 kg, 11 kg, 33 kg and gas soldering equipment with hose connection G 3/8" L

Art.-No : 032081E - 0.5 – 4 bar

EAN: 4004625320815



BOTHENBERGER INDUSTRIAL

PROPANE REGULATOR WITH MANOMETER € 32,11

0.5 – 4 bar | W 21.8 x 1/14" L / G 3/8" L-D max. 8 kg/h. DVGW-checked. For propane gas bottles 5 kg, 11 kg, 33 kg. and gas soldering equipment with hose connection G 3/8" L

Art.-No : 032100E - Includes Manometer, infinitely adjustable

EAN: 4004625321003



BOTHENBERGER INDUSTRIAL

PROPANE REFILL CONNECTION € 22,28

For connection to propane gas bottles 5 kg, 11 kg, 33 kg For the filling of propane small bottles (033079)

Art.-No : 032207E - W 21,8" L / G 3/8" L

EAN: 4004625322079



BOTHENBERGER INDUSTRIAL

DOUBLE NIPPLE

For the secure lengthening of propane gas hoses Extension of propane gas hoses. Extension of propane gas hoses.

Art.-No : 540251E - Connection: 2x G 1/4" L - price: € 7,59

EAN: 4004625402511

Art.-No : 540255E - Connection: 2x G 3/8" L - price: € 7,38

EAN: 4004625001929



CAMPING, GARDEN & HOUSEHOLD

ROTHENBERGER
INDUSTRIAL

CRÈME BRÛLÉE SET

€ 36,77

Creative in the kitchen with the professional gourmet burner. Working temperature: 450°C. The Gourmet Burner is designed for cooking foodstuffs. Whether used for the flambé, caramelisation, browning, gratinising of food and desserts, the crème brûlée Gourmet Burner makes this easy and secure.

Art.-No.: 035126E

EAN: 4004625053065



ROTHENBERGER
INDUSTRIAL

SCOUT CAMPING LAMP

€ 42,78

The mobile light for camping, household and garden.

Art.-No.: 35902

EAN: 4004625359020



ROTHENBERGER
INDUSTRIAL

DUO CAMPING COOKER

€ 97,40

The mobile cooker for camping, household and garden. Power Rating: large burner: 1.70 kW, middle burner: 1.20 kW. Consumption: large burner: 121 g/h, middle burner: 85 g/h. Connect to propane gas bottles (5 kg and 11 kg) with pressure reducer 50 mbar. With hose (0.8 m). Connection: G 1/4" L and controller (50 mbar). Recommended for Ø 16 – 22 cm heads.

Art.-No.: 35940

EAN: 4004625359402



ROTHENBERGER
INDUSTRIAL

ELECTRIC WEEDKILLER

€ 60,62

Fast environmentally friendly burning or charring of weeds. Rated voltage: 230 V / 50 Hz, 2 metre cable, 2000 W.

Art.-No.: 1500002183

EAN: 4004625405710



ROTHENBERGER
INDUSTRIAL

BUNSEN BURNER

€ 25,39

The ideal burner for heating in goldsmith and laboratory work as well as in glass and plastic processing. Flame temperature: 900°C. Gas consumption in normal use: 45 g/h / 1.0 kW.

Art.-No.: 1500000194

EAN: 4004625371503



ROTHENBERGER
INDUSTRIAL

SCOUT CAMPING COOKER

€ 30,90

The mobile stove for camping, household and garden. Cooking edition: approximately 14 cm. Operate with piercing Supergas C200 cartridge.

Art.-No.: 35904

EAN: 4004625359044



ROTHENBERGER
INDUSTRIAL

BENCH COOKER

€ 72,56

The ideal companion for camping, outdoor and leisure. Burner made of solid cast iron. Stable construction made of sheet steel. 7.5kW.

Art.-No.: 1500001392

EAN: 4004625396223



ROTHENBERGER
INDUSTRIAL

STANDARD GAS LIGHTER

€ 4,21

Piezo ignition, Fuel gauge, rigger lock, Refillable, Child safety lock.

Art.-No.: 035990E

EAN: 4004625359907



ACCESSORIES + SANITARY INSTALLATION

PROPANE CONSTANT REGULATOR

€ 10,05

Pressure: 50 mbar | Input: W 21,8 x 1/1 4" L — Output: G 1/4" L.
Consumption: 1.5 kg/h. For heating, boiling and roasting apparatus.
For 5 to 11 kg propane gas bottles. 50 mbar

Art.-No : 035921E

EAN: 4004625359211



INCANDESCENT MANTLE

€ 3,77

For gas lamps, 3 pieces

Art.-No : 035908E

EAN: 4004625359082



ROBBQ THERMOMETER

€ 43,50

To record the exact temperature of meat, chicken, fish, beef, pork or potatoes, baby food etc., Incl. scale for exact reading of the optimal cooking level. Digital temperature display. Very easy to use. Batteries included !

Art.-No : 1500003370

EAN: 4004625521953



SCOUT REPLACEMENT GLASS

€ 10,85

Heat-resistant safety glass for camping lamps

Art.-No : 35907

EAN: 4004625359075



COPPER PIPE INNER BRUSH

For quick cleaning of solder fittings

Art.-No : 854181 - iam. 12mm - Price € 8,99

EAN: 4004625541814

Art.-No : 854183 - diam. 15mm - Price € 8,99

EAN: 4004625541838

Art.-No : 854185 - diam. 18mm - Price € 8,99

EAN: 4004625541852

Art.-No : 854186 - diam. 22mm - Price € 8,99

EAN: 4004625541869



SANITARY INSTALLATION

ROTHENBERGER
INDUSTRIAL

SANIKIT

€ 236,55

The professional complete set in a plastic case for the handyman. Product coverage for all installation work in plumbing and heating systems. Ideal for repair and assembly as well as separating steel pipes up to $\varnothing 1\frac{1}{4}$ " (31.75 mm). Threading to $\varnothing 1$ " (25.4 mm). Recommendation: Always use thread cutting oil (eg Ronol Syn 65013). Assembly, screw fittings, grommets and sealing of threaded fasteners. Up to $\varnothing 1\frac{1}{4}$ " (31.75 mm)

Art.-No : 070673E

EAN: 4004625706732



ROTHENBERGER
INDUSTRIAL

TUBE CUTTER 35

€ 33,62

Telescopic pipe cutters. Robust construction and two guide rollers with recess for hemming sewing section. For cutting copper, brass, aluminium and thin-walled steel pipes. \varnothing : 6 mm – 35 mm ($1/4$ " – $1\frac{3}{8}$ "")

Art.-No : 070941E

EAN: 4004625709412



ROTHENBERGER
INDUSTRIAL

MINIMAX

€ 20,90

Pipe cutters. With two support rollers with groove for flanged seam section. For cutting copper, brass, aluminium and thin-walled steel pipes. \varnothing : 3 mm – 29 mm ($1/8$ " – $1\frac{1}{8}$ "")

Art.-No : 070644E

EAN: 4004625706442



ROTHENBERGER
INDUSTRIAL

STEEL PIPE CUTTER

€ 51,51

Width rollers for reliable guidance and chrome plated spindle. All-steel, drop forged. With chrome plated stem and wide rolls for safe operation. Ideal for exact cutting of steel pipes. \varnothing : 10 mm – 42 mm ($1/8$ " – $1\frac{1}{4}$ "")

Art.-No : 070643E

EAN: 4004625706435



ROTHENBERGER
INDUSTRIAL

TUBE CUTTER 30

€ 19,76

Pipe cutters, Robust monobloc sledge and two guide rollers with recess for hemming sewing section. For cutting copper, brass, aluminium and thin-walled steel pipes.

\varnothing : 3 mm – 30 mm ($1/8$ " – $1\frac{1}{8}$ "")

Art.-No : 070641E

EAN: 4004625706411



ROTHENBERGER
INDUSTRIAL

TUBE CUTTER 42

€ 48,49

Telescopic pipe cutters, Robust construction and two guide rollers with recess for hemming sewing section. For cutting copper, brass, aluminium and thin-walled steel pipes.

\varnothing : 3 mm – 42 mm ($1/8$ " – $1\frac{5}{8}$ "")

Art.-No : 070642E

EAN: 4004625706428



ROTHENBERGER
INDUSTRIAL

MINICUT

€ 11,15

Pipe cutters, With two support rollers with groove for flanged seam section. For cutting copper, brass, aluminium and thin-walled steel pipes. \varnothing : 3 mm – 22 mm ($1/8$ " – $7/8$ "")

Art.-No : 070640E

EAN: 4004625706404



ROTHENBERGER
INDUSTRIAL

PIPE VICE

€ 85,29

All-steel forged, hinged. Ideal for pipe working in plumbing and heating installation. \varnothing : 10 mm – 60 mm ($1/8$ " – 2")

Art.-No : 070674E

EAN: 4004625706749



ROTHENBERGER
INDUSTRIAL

INTERNAL AND EXTERNAL DE-BURRING TOOL € 15,60

For effortless deburring of the cut surfaces of copper, aluminium and mild steel pipes. The special arrangement of three ground and hardened steel blade guarantees smooth surfaces without grooves
Ø: 4 mm – 36 mm

Art.-No : 011080E

EAN: 4004625110805



ROTHENBERGER
INDUSTRIAL

MINIBEND 6-8-10MM € 33,75

Hand bending device. Areas of application. Two-hand bending up to 180° of pipes made of soft copper, brass, aluminum and steel. Refrigeration and air conditioning technology, Automotive, hydraulic and compressed air technology
Application benefits, Undersize and bending angle display on the bending scale
Ø: 6 – 8 – 10 mm (1/4" – 5/16" – 3/8")

Art.-No : 025160E

EAN: 4004625251607



ROTHENBERGER
INDUSTRIAL

WATER PUMP PLIERS

Chrome vanadium steel, Drop forged, Hardened, Smoothed plier head. Self-clamping jaws, Induction hardened teeth, Crush and pinch protection on the handles, 7 settings. For secure holding of pipes and flat material, as well as square and hexagonal screw connections? Ideal for hard to reach places due to long, slender plier head – excellent for corners.



Art.-No : 070651E - Ø: 1" / 33 mm | Length: 180 mm / 7" : price: € 19,27

EAN: 4004625706510

Art.-No : 070652E - Ø: 1 1/2" / 48 mm | Length 300 mm / 12": price: € 26,75

EAN: 4004625706527

Art.-No : 070650E - Ø: 1 1/4" / 42 mm | Length: 250 mm / 10": price: € 24,23

EAN: 004625706503

ROTHENBERGER
INDUSTRIAL

HEMP DISPENSER € 7,96

For thread sealing in heating and plumbing technology.

Art.-No : 070623E - Length: 40 m

EAN: 4004625006979



ROTHENBERGER
INDUSTRIAL

TUBE CUTTER 30 € 25,45

Chrome vanadium special steel, Drop forged, Very robust
Ideal for installation of stand taps of washbasins, Optimum power transmission due to handle, Swivel claw for clockwise and counterclockwise operation
Ø: 10 mm – 32 mm (3/8 – 1 1/4") | Length: 275 mm

Art.-No : 070676E

EAN: 4004625706763



ROTHENBERGER
INDUSTRIAL

GRATFIX HSS € 30,48

With exchangeable HSS universal blade, For deburring edges on pipes, fittings, holes, etc. Always a spare blade at hand, Blade reservoir in the handle

Art.-No : 021659E

EAN: 4004625216590



ROTHENBERGER
INDUSTRIAL

45° CORNER PIPE WRENCH

Chrome vanadium steel, All-steel, drop forged, Hardened, S-shaped mouth, Reinforced sleeve, Smoothed jaws, Secure and non-slip grip by staggered toothing
For secure holding of pipes, screw fittings, round materials, etc.
Clamp protection prevents jamming, Universal use in the installation area.



Art.-No : 070656E - Ø: 1" / 33 mm | Length: 320 mm / 12": price: € 28,58

EAN: 4004625706565

Art.-No : 070657E - Ø: 1 1/2" / 48 mm | Length: 425 mm / 16": price: € 36,36

EAN: 4004625706572

Art.-No : 070658E - Ø: 2" / 60 mm | Length: 560 mm / 20": price: € 53,67

EAN: 4004625706589

ROTHENBERGER
INDUSTRIAL

RADIATOR AIR VENT € 11,81

For optimum venting of radiators, 5 mm square, heat-resistant, Quick and clean thanks collecting receptacle

Art.-No : 1500001265

EAN: 4004625392911



HEATERS & ACCESSORIES + INSPECTION DEVICES - SPECIAL TOOLS

PROPANE GAS HOSE LINE

Pressure: 2 MPa (20 bar), Ø 5 mm, Connection: 2 x G 3/8" L, certified according EN 1327. Can be used in conjunction with double nipple (item 540255E) as an extension tube)



Art.-No : 035914E - Length: 0.4 m - price: € 8,18

EAN: 4004625359143

Art.-No : 035915E - Length: 0.8 m - price: € 12,97

EAN: 4004625359150

Art.-No : 035916E - Length: 1.5 m - price: € 20,17

EAN: 4004625359167

Art.-No : 035917E - Length: 3.0 m - price: € 20,90

EAN: 4004625359174

90° FITTING PLIER

€ 33,60

Chrome vanadium special steel, All-steel, drop-forged. Plastic jaws ensure safe and gentle grip especially for chrome fittings and polished surfaces, fittings or metal sheets. Non-slip side shape, Anti-trap prevents jamming. Jaws made of special plastic



Art.-No : 070659E - Ø: 1" / 35 mm

EAN: 4004625706596

ROCUT 26 PLASTIC PIPE SHEAR

€ 19,39

Ideal for plumbers, fitters and mechanics. For effortless cutting of plastic pipes and multi-layer composite pipes. With ratchet mechanism for optimal power transfer



Art.-No : 36099 - Ø: 42 mm

EAN: 4004625360996

SANIGRIP

€ 18,33

Syphon pliers, Chrome vanadium special steel. All-steel forged, Chrome plated, Mounted plastic jaws. Tightening and releasing of plastic pipe threaded connections, Installation of filtering equipment in swimming pool area with round union nuts up to Ø 62 mm (siphon)



Art.-No : 070662E - Clamping range: 15 – 62 mm, Length: 10", 250 mm

EAN: 4004625706626

ECO GAS HEATER

€ 81,03

Tower heating units for propane gas bottles Performance: min. 2.70 kW / max. 4.20 kW., Consumption: 0.2 – 0.37 kg/h, Suitable for propane gas bottles 5 kg and 11 kg, Performance: 2.7 – 4.2 kW Art.-No : 35984

EAN: 4004625359846



ECO PIEZO GAS HEATER

€ 84,90

Tower heating units for propane gas bottles, Performance: min. 2.70 kW / max. 4.2 kW., Consumption: 0.2 – 0.37 kg/h, Modell with piezo ignition, Suitable for propane gas bottles 5 kg and 11 kg, Performance: 2.7 – 4.2 kW Art.-No : 35985

EAN: 4004625359853



PLASTIC PIPE CUTTER

€ 30,97

Ideal for plumbers, fitters and mechanics. For effortless cutting of plastic pipes and multi-layer composite pipes, Adjustable blade base position, Use a screwdriver to change the blade



Art.-No : 36010 - Ø: 36 mm

EAN: 4004625360101

PREMIUM PLASTIC PIPE SHEARS

€ 26,26

Ideal for plumbers, fitters and mechanics, For effortless cutting of plastic pipes and multi-layer composite pipes. With stainless steel blade and safety latch



Art.-No : 36012 - Ø: 42 mm

EAN: 4004625360125

TEFLON BAND

€ 5,69

In practical dispenser. For clean sealing of metal and plastic screw threads

Art.-No : 070624E - Length: 40 m

EAN: 4004625706244



SAFETY



SAFETY AT WORK

SAFETY SHOES

DUCATI RACING LINE

LE MANS S3

€ 118,62

UPPER	Waxy black full grain TOP LEATHER
LINING	100% honeycomb finished polyester
INSOLE	Sport-Lite, anatomic, antistatic and antibacterial
SOLE	Double density polyurethane
TOE CAP	Non-Metallic Thin Cap
MIDSOLE	Non-Metallica HRP INSOLE
INSTEP	12
SIZES:	38-47



ASSEN S3

€ 125,80

UPPER	Waxy black full grain TOP LEATHER
LINING	100% honeycomb finished polyester
INSOLE	Sport-Lite, anatomic, antistatic and antibacterial
SOLE	Double density polyurethane
TOE CAP	Non-Metallic Thin Cap
MIDSOLE	Non-Metallica HRP INSOLE
INSTEP	12
SIZES:	38-47



MUGELLO S1P

€ 111,89

UPPER	Safety-Tex with padded storm-cuff
LINING	100% honeycomb finished polyester
INSOLE	Sport-Lite, anatomic, antistatic and antibacterial
SOLE	Double density polyurethane
TOE CAP	Non-Metallic Thin Cap
MIDSOLE	Non-Metallica HRP INSOLE
INSTEP	12
SIZES:	38-48



SAFETY SHOES

SPORT LINE

SEPANG S3 SRC

€ 129,68



UPPER Black microfiber-Mesh with padded storm-cuff
 LINING 100% honeycomb finished polyester
 INSOLE Sport-Lite , anatomic, antistatic and antibacterial
 SOLE Double density polyurethane
 TOE CAP Non-Metallic THIN CAP
 MIDSOLE Non-Metallic HRP INSOLE
 INSTEP 12
 SIZES: 34-48



VALENCIA S3 SRC

€ 136,80



UPPER Black microfiber-Mesh with padded storm-cuff
 LINING 100% honeycomb finished polyester
 INSOLE Sport-Lite, anatomic, antistatic and antibacterial
 SOLE Double density polyurethane
 TOE CAP Non-Metallic THIN CAP
 MIDSOLE Non-Metallic HRP INSOLE
 INSTEP 12
 SIZES: 3-47



JUDOS1P

€ 88,24



UPPER STRETCH TEX with padded storm-cuff
 LINING 100% honeycomb finished polyester
 INSOLE SPORT-LITE, anatomic, antistatic and antibacterial
 SOLE Double density polyurethane
 TOE CAP Non-Metallic THIN CAP
 MIDSOLE Non-Metallic HRP INSOLE
 INSTEP 12
 SIZES: 35-47



KAYAK S3

€ 90,40



UPPER STRETCH TEX with padded storm-cuff
 LINING 100% honeycomb finished polyester
 INSOLE SPORT-LITE, anatomic, antistatic and antibacterial
 SOLE Double density polyurethane
 TOE CAP Non-Metallic THIN CAP
 MIDSOLE Non-Metallic HRP INSOLE
 INSTEP 12
 SIZES: 35-47



SAFETY SHOES

SPORT LINE

BASKET LOW S3

€ 92,74



UPPER	Black Safety-Nubuk with padded storm-cuff. HIGH-TEX inserts
LINING	100% honeycomb finished polyester
INSOLE	SPORT-LITE, anatomic, antistatic and antibacterial
SOLE	Double density polyurethane
TOE CAP	Non-Metallic THIN CAP
MIDSOLE	Non-Metallic HRP INSOLE
INSTEP	12
SIZES:	35-48



CARVING S1P

€ 96,44



UPPER	Blue suede leather with padded storm-cuff . HIGH-TEX inserts
LINING	100% honeycomb finished polyester
INSOLE	SPORT-LITE, anatomic, antistatic and antibacterial
SOLE	Double density polyurethane
TOE CAP	Non-Metallic THIN CAP
MIDSOLE	Non-Metallic HRP INSOLE
INSTEP	12
SIZES:	38-47



SNOWBOARD S3

€ 99,58



UPPER	Waxy black full grain TOP LEATHER
LINING	100% honeycomb finished polyester
INSOLE	SPORT-LITE, anatomic, antistatic and antibacterial
SOLE	Double density polyurethane
TOE CAP	Non-Metallic THIN CAP
MIDSOLE	Non-Metallic HRP INSOLE
INSTEP	12
SIZES:	34-42



SAFETY SHOES

MUSIC LINE

BLUES LOW S1P

€ 75,75



UPPER	Blue reinforced cotton
LINING	Non-woven fabric
INSOLE	ERGO-FIT, anatomic and antistatic
SOLE	Double density polyurethane
TOE CAP	Steel
MIDSOLE	Non-Metallic HRP INSOLE
INSTEP	11
SIZES:	35-47



BLUES HIGH S1P

€ 79,17



UPPER	Blue reinforced cotton
LINING	Non-woven fabric
INSOLE	ERGO-FIT, anatomic and antistatic
SOLE	Double density polyurethane
TOE CAP	Steel
MIDSOLE	Non-Metallic HRP INSOLE
INSTEP	11
SIZES:	38-47



SAFETY SHOES

REVOLUTION LINE

NICE S1P

€ 82,99



UPPER	Black microfibre. HIGH-TEX inserts
LINING	100% honeycomb finished polyester
INSOLE	LIGHT & SOFT, antistatic and breathable
SOLE	Polyurethane
TOE CAP	Non-Metallic TOP COMPOSITE
MIDSOLE	Non-Metallic HRP INSOLE
INSTEP	12
SIZES:	38-48



SAFETY SHOES

COMFORT LINE

CONCORDE S3

€ 128,71



BOA®

UPPER Black Safety-Nubuk with padded storm-cuff.
HIGH-TEX inserts
LINING 100% honeycomb finished polyester
INSOLE Atomic
SOLE Translucid double density polyurethane
TOE CAP Non-Metallic TOP COMPOSITE
MIDSOLE Non-Metallic HRP INSOLE
INSTEP 12
SIZES: 38-48



PIPER S3

€ 74,84



UPPER Black smooth grain leather with padded storm-cuff.
HIGH-TEX inserts
LINING 100% honeycomb finished polyester
INSOLE LIGHT & SOFT, antistatic and breathable
SOLE Translucid double density polyurethane
TOE CAP Non-Metallic TOP COMPOSITE
MIDSOLE Non-Metallic HRP INSOLE
INSTEP 12
SIZES: 35-47



LEGEND S3

€ 76,32



UPPER Black smooth grain leather with padded storm-cuff.
HIGH-TEX inserts
LINING 100% honeycomb finished polyester
INSOLE LIGHT & SOFT, antistatic and breathable
SOLE Translucid double density polyurethane
TOE CAP Non-Metallic TOP COMPOSITE
MIDSOLE Non-Metallic HRP INSOLE
INSTEP 12
SIZES: 35-47



HALIFAX S3

€ 85,44



UPPER Waxy brown full grain TOP LEATHER
LINING 100% honeycomb finished polyester
INSOLE LIGHT & SOFT, antistatic and breathable
SOLE Translucid double density polyurethane
TOE CAP Non-Metallic TOP COMPOSITE
MIDSOLE Non-Metallic HRP INSOLE
INSTEP 12
SIZES: 35-47



HRP
INSOLE
111

12

PRO-CAP

METAL
FREE

TOP
LEATHER



CONVAIR S3

€ 91,03



UPPER Waxy brown full grain TOP LEATHER
LINING 100% honeycomb finished polyester
INSOLE LIGHT & SOFT, antistatic and breathable
SOLE Translucid double density polyurethane
TOE CAP Non-Metallic TOP COMPOSITE
MIDSOLE Non-Metallic HRP INSOLE
INSTEP 12
SIZES: 35-47



FALCON S3

€ 147,69



UPPER Black Safety-Nubuk with padded storm-cuff.
LINING HIGH-TEX inserts
INSOLE 100% honeycomb finished polyester
SOLE SPORT-LITE, anatomic, antistatic and antibacterial
TOE CAP Double density polyurethane
MIDSOLE Non-Metallic THIN CAP
INSTEP Non-Metallic HRP INSOLE
SIZES: 12
38-48



BLACKBURN S3

€ 98,27



UPPER Eco Leather
LINING Warm lining, 80% polyester and 20% acrylic
INSOLE THERMO-PLUS, with a high thermal isolation
SOLE Double density polyurethane
TOE CAP Non-Metallic TOP COMPOSITE
MIDSOLE Non-Metallic HRP INSOLE
INSTEP 12
SIZES: 36-48



**A GREAT ACHIEVEMENT OF INNOVATION,
DEVELOPED FOR YOUR COMFORT.**

**Soft Walk is a cushion designed for the highest
requirements of comfort and performance.**

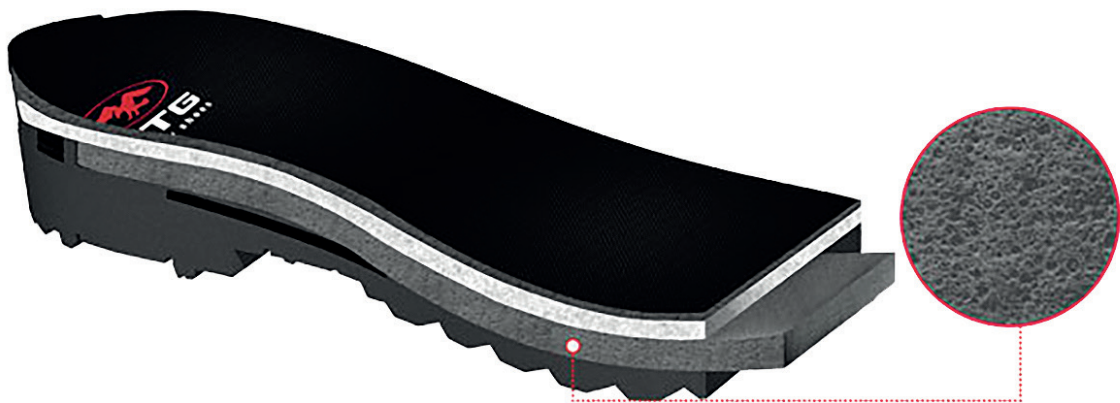

An anti-impact system, inserted directly into the sole in contact with the insole, allows you to walk on a particularly soft surface, greatly reducing the weight of the footwear.

An excellent result in wellbeing and rest for the foot, at maximum levels of performance and safety.

SAFETY SHOES

PROFESSIONAL LINE



DOUGLAS S3

€ 89,49



UPPER	Black Nubuk with padded storm-cuff
LINING	100% honeycomb finished polyester
INSOLE	Atomic
SOLE	Translucid double density polyurethane with overcap
TOE CAP	Non-Metallic TOP COMPOSITE
MIDSOLE	Non-Metallic HRP INSOLE
INSTEP	12
SIZES:	36-48



GLADIATOR S3

€ 92,23



UPPER	Black Nubuk with padded storm-cuff
LINING	100% honeycomb finished polyester
INSOLE	Atomic
SOLE	Translucid double density polyurethane with overcap
TOE CAP	Non-Metallic TOP COMPOSITE
MIDSOLE	Non-Metallic HRP INSOLE
INSTEP	12
SIZES:	36-48



JUNKERS S3

€ 86,75



UPPER	Black Safety-Nubuk with padded storm-cuff. HIGH-TEX inserts
LINING	100% honeycomb finished polyester
INSOLE	Atomic
SOLE	Translucid double density polyurethane with overcap
TOE CAP	Non-Metallic TOP COMPOSITE
MIDSOLE	Non-Metallic HRP INSOLE
INSTEP	12



FIREBRAND S3

€ 92,85



UPPER	Black Safety-Nubuk with padded storm-cuff. HIGH-TEX inserts
LINING	100% honeycomb finished polyester
INSOLE	LIGHT & SOFT, antistatic and breathable
SOLE	Translucid double density polyurethane
TOE CAP	Non-Metallic TOP COMPOSITE
MIDSOLE	Non-Metallic HRP INSOLE
INSTEP	12
SIZES:	38-48



SAFETY SHOES

PROFESSIONAL LINE

METEOR S3

€ 70,62



UPPER	Brown waxy grain leather with padded storm-cuff
LINING	100% honeycomb finished polyester
INSOLE	Atomic
SOLE	Translucid double density polyurethane with overcap
TOE CAP	Non-Metallic TOP COMPOSITE
MIDSOLE	Non-Metallic HRP INSOLE
INSTEP	12
SIZES:	38-48



JET S3

€ 73,87



UPPER	Brown waxy grain leather with padded storm-cuff
LINING	100% honeycomb finished polyester
INSOLE	Atomic
SOLE	Translucid double density polyurethane with overcap
TOE CAP	Non-Metallic TOP COMPOSITE
MIDSOLE	Non-Metallic HRP INSOLE
INSTEP	12
SIZES: 3	8-48



ECO-LEATHER

Ecological, washable and non-allergic material

Transpires more than double!*

Washable at 30°C without deformation

Hypoallergenic



Chrome free

Acid resistant

Environmentally friendly

That's why we have developed the best solution for footwear offering high performance and excellent appearance, without giving up eco-friendly and sustainable material.

ECO leather is chrome-free, breathable and acid-resistant, because health is a fundamental part of safety at the highest levels. The shoe is machine washable at 30°, maintaining its shape and characteristics, while ensuring fast, practical washing.

SAFETY SHOES

GEMINI LINE



ECO BOX
ECO PAPER
65% ECO PU
ECO RELEASE AGENT

+25% LIGHT
ECO FACILITIES
20% ENERGY
VEGAN FRIENDLY

MERCURY S3



UPPER
LINING
INSOLE
SOLE
TOE CAP
MIDSOLE
INSTEP
SIZES:

Black Safety-Nubuk with padded storm-cuff. HIGHTEX inserts
100% honeycomb finished polyester
ATOMIC, anatomic, antistatic, breathable and ESD
Polyurethane with TPU inserts
Non-metallic TOP COMPOSITE

SIZES: 34-48 = € 72,31

SIZES: 49-50 = € 112,23



URANUS S3



UPPER
LINING
INSOLE
SOLE
TOE CAP
MIDSOLE
INSTEP
SIZES:

Black Safety-Nubuk with padded storm-cuff. HIGH-TEX inserts
100% honeycomb finished polyester
ATOMIC, anatomic, antistatic, breathable and ESD
Polyurethane with TPU inserts
Non-metallic TOP COMPOSITE

SIZES: 36-48 = € 79,45

SIZES: 49-50 = € 119,39



CHARON S1P

€ 69,60



UPPER
LINING
INSOLE
SOLE
TOE CAP
MIDSOLE
INSTEP
SIZES:

Black Safety-Nubuk with padded storm-cuff. HIGH-TEX inserts
100% honeycomb finished polyester
ATOMIC, anatomic, antistatic, breathable and ESD
Polyurethane with TPU inserts
Non-metallic TOP COMPOSITE

SIZES: 34-48



SATURN S1P

€ 65,62



UPPER
LINING
INSOLE
SOLE
TOE CAP
MIDSOLE
INSTEP
SIZES:

Black microfiber with padded storm-cuff. HIGH-TEX inserts
100% honeycomb finished polyester
RELAX, antistatic and breathable
Polyurethane with TPU inserts
Non-metallic TOP COMPOSITE

SIZES: 38-48



SAFETY SHOES

GEMINI LINE

MOON S1P

€ 70,40



UPPER	Black microfiber with padded storm-cuff. HIGH-TEX inserts
LINING	100% honeycomb finished polyester
INSOLE	RELAX, antistatic and breathable
SOLE	Polyurethane with TPU inserts
TOE CAP	Non-metallic TOP COMPOSITE
MIDSOLE	Non-metallic HRP INSOLE
INSTEP	12
SIZES:	38-48



SPACE S3

€ 56,09



UPPER	Black Safety Leather with padded storm-cuff. HIGH-TEX inserts
LINING	100% honeycomb finished polyester
INSOLE	RELAX, antistatic and breathable
SOLE	Translucid double density polyurethane
TOE CAP	Non-metallic TOP COMPOSITE
MIDSOLE	Non-metallic HRP INSOLE
INSTEP	12
SIZES:	36-48



STAR S3

€ 60,25



UPPER	Black Safety Leather with padded storm-cuff. HIGH-TEX inserts
LINING	100% honeycomb finished polyester
INSOLE	RELAX, antistatic and breathable
SOLE	Translucid double density polyurethane
TOE CAP	Non-metallic TOP COMPOSITE
MIDSOLE	Non-metallic HRP INSOLE
INSTEP	12
SIZES:	36-48



OLYMPIA LINE

APOLLO S3

€ 99,52



UPPER	Black smooth grain leather with padded storm-cuff
LINING	100% honeycomb finished polyester
INSOLE	LIGHT & SOFT, antistatic and breathable
SOLE	Dual component, polyurethane-rubber
TOE CAP	Non-Metallic TOP COMPOSITE
MIDSOLE	Non-Metallic HRP INSOLE
INSTEP	12
SIZES:	38-48



WHITE LINE



SAFETY SHOES

WHITE LINE

CHEF WHITE + CHEF BLACK S2

€ 42,86



UPPER	White microfiber, water-repellent
LINING	100% honeycomb finished polyester
INSOLE	FTG-AIR WHITE/BLACK, extractable and washable
SOLE	Polyurethane white
TOE CAP	Steel
INSTEP	11
SIZES:	34-48



COOK WHITE + COOK BLACK SB A E WRU FO

€ 33,37



UPPER	White microfiber, water-repellent
LINING	100% honeycomb finished polyester
INSOLE	FTG-AIR WHITE/BLACK, extractable and washable
SOLE	Polyurethane white
TOE CAP	Steel
INSTEP	11
SIZES:	34-48



SOCKS

JCB BLACK LABEL SOCKS



SOCKS

JCB BLACK LABEL SOCKS



JCB PRO RIGGER BOOT-GREY/BLACK - 1 PAIR

€ 9,45

Extra long aerobic cuff
Silver anti-bacterial treatment
Reinforced heel and toe
Comfort cushioning throughout

JCBX051 - 39/43 - EAN: 5018057412283
JCBX052 - 44/47 - EAN: 5018057412290



SILVER
With Silverplus to keep socks hygienic and smelling fresh by directly controlling bacteria on the sock surface with antimicrobially active silver ions.



JCB PRO COOLMAX SOCK - 1 PAIR

€ 8,86

Coolmax-wicks sweat away & keeps feet dry and comfortable
Comfort hold cuff
Reinforced heel and toe
Comfort cushioning throughout
Ventilation panels
Ribbed arch support

JCBX115 - 39/43 - EAN: 5018057421155
JCBX116 - 44/47 - EAN: 5018057421162



JCB PRO ANTI BLISTER SOCK - COTTON RICH - 1 PAIR

€ 9,63

Double layer anti blister protection
Deep loose aerobic cuff
Reinforced heel and toe
Comfort cushioning throughout
Ribbed arch support

JCBX106 - 39/43 - EAN: 5018057421001
JCBX107 - 44/47 - EAN: 5018057421018



JCB PRO WOOL SOCK - 1 PAIR

€ 8,86

Soft wool blend yarns-wicks away moisture, keeping feet warm in winter & cool in summer
Deep loose aerobic cuff
Reinforced heel and toe
Comfort cushioning throughout
Anti rub patches
Ribbed arch support

JCBX113 - 39/43 - EAN: 5018057421063
JCBX114 - 44/47 - EAN: 5018057421070



JCB PRO TECH WELLY SOCK - 1 PAIR

€ 9,45

Cotton rich
REACTIVE sole
Full terry comfort
Aerobic welt
Reinforced heel and toe

JCBX102 - 39/43 - EAN: 5018057420868
JCBX103 - 44/47 - EAN: 5018057420875



The JCB range uses specialized treatments and yarns, these that are used include.

REACTIVE™

Reactive Yarn Technology

Warmer than wool and lighter than polyester and nylon, this yarn provides bulk and warmth for less weight. With hydrophobic qualities it is quick drying, wicking moisture away from the skin and through the fabric for quick evaporation.



Trevira Bioactive

Trevira Bioactive is a new generation of polyester fibre with silver ions permanently embedded. Compared to conventional polyester, the fibre is much improved in terms of strength and breathability, as well as having antimicrobial properties.

Coolmax



COOLMAX® technology is engineered for everyday comfort and performance with added cooling and drying benefits.



Aegis

A specially designed treatment which helps keep your socks fresh and odour free.

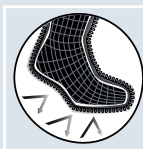

Anti-Shock

Cushion looping gives comfort, absorbs sweat, and acts as a barrier between the foot and ground for added shock absorption.



Ventilation

In regular and extreme conditions feet can get irritated by heat and sweat from all the action on a busy day, ventilation panels aim to reduce this issue and let feet breathe.



Flexible Support

We have a range of knit structures to support the movement and support you need day to day, whether you need a firm grip or a relaxed hold for better circulation.



Blister Protection

Reinforced heel and toe areas for extra protection from rubbing within shoes and work boots.

SOCKS

JCB MULTI PACKS

JCB

JCB OUTDOOR ACTIVITY SOCKS - 3 PACK

€ 14,04

Great protection for the great outdoors comes packaged as the JCB outdoor activity socks. Features include Aegis anti-bacterial wash, compression ribbing, arch support band, cushioned terry loop throughout, and reinforced heel and toe.

JCBX021 - 39/43 - EAN: 5018057409504 - BLACK
 JCBX022 - 44/47 - EAN: 5018057409511 - BLACK
 JCBX023 - 39/43 - EAN: 5018057409528 - NAVY/BLACK/GREY
 JCBX024 - 44/47 - EAN: 5018057409535 - NAVY/BLACK/GREY



JCB

JCB OUTDOOR CASUAL SOCKS - 3 PACK

€ 7,92

High cotton content and cushioned terry comfort throughout for the great outdoors.

JCBX039D - 39/46 - EAN: 5018057424934
 JCBX039E - 39/46 - EAN: 5018057424941



JCB

JCB WORK SOCKS - 3 PACK - BLACK

€ 7,70

One of our first JCB workwear products that has become a staple in our essentials line. Features include reinforced heel and toe, terry cushioning, and lightweight breathable body.

JCBX044E - 39/43 - EAN: 5018057421759
 JCBX044 - 44/47 - EAN: 5018057412405



JCB

JCB ACTIVE HYBRIDE SOCKS - 3 PACK

€ 13,22

REACTIVE yarn footbed to wick away moisture
 Focused cushioned terry comfort
 Ventilation panels
 Reinforced heel and toes

JCBX080 - 39/43 - EAN: 5018057416861
 JCBX081 - 44/47 - EAN: 5018057416908

ACTIVE HYBRID

WORK. REST. PLAY



JCB**THERMA SOCKS - 1 PACK****€ 10,22**

Extreme thermal sock with:
 REACTIVE yarn technology
 Reinforced heel and toes
 4 x warmer than cotton socks
 Comfort terry cushioning
 Brushed inner

JCBX099 - BLACK/RED - 39/43 - EAN: 5018057420004
 JCBX100 - BLACK/RED - 44/47 - EAN: 5018057420981

**JCB****JCB HEAVY DUTY WORK SOCKS - 3PACK****€ 12,95**

JCB heavy duty socks with:
 Reinforced heel and toes
 JCB logo and tipping detail
 Thick cushioned terry throughout

JCBX000108A - 39/46 - EAN: 5018057423838
 JCBX000108B - 44/47 - EAN: 5018057423845

**JCB****ADVANTAGE SOCK****€ 8,25**

Hard-wearing sock ideal for steel toe boots
 Comfort terry cushioning tot he foot
 Comfort stretch rib to support in the leg
 Reinforced heel, toe an extended achilles area

JCBX098A - 39/46 - EAN: 5018057428154
 JCBX098B - 44/47 - EAN: 5018057428161

**JCB****EVERY DAY WORK SOCK****€ 12,08**

Intermediate weight sock for all year round
 Cushioned sole for underfoot comfort
 Ventilation mesh panel to keep feet cooler
 Reinforced geel, toe and extended achilles area.

JCBX138A - 39/46 - EAN: 5018057425207
 JCBX138B - 44/47 - EAN: 5018057423845

**JCB****JCB TRAINER LINER - 3 PACK****€ 10,40**

The Activewear trainer liner features include:
 Deep grip welt. Arch support band.
 Comfort terry cushion sole. Ventilation Panel.
 Reinforced heel and toe. Treated with Biome an acti-bacterial technology
 which keeps your socks fresh and odour free.

JCBX000129 - 39/43 - EAN: 5018057422817
 JCBX000130 - 44/47 - EAN: 5018057422824

**JCB****PRO BOOT SOCK****€ 13,13**

Breathable soft grip aerobic knit welt
 Comfort terry cushioning troughout acts as anti-shock
 Reinforced heel and toe
 Reactive yarn technology

JCBX083A - 39/43 - EAN: 5018057424910
 JCBX083B - 44/47 - EAN: 5018057424927





PRIVATE LABEL SOCKS

Contact us to have your own 3-pack worksocks
We can produce all qualities

PROTECTIVE GLOVES



STANLEY

RAZOR TREAD GRIPPER GLOVES

€ 7,24

- Breathable Knit Back for comfortable fit
- Razor Tread Gripper Pattern provides extra grip
- Seamless Fit for flexibility and comfort

SKU	SIZE	PALM	EAN
SY510M EU	9	RAZOR TREAD PATTERN	0674326263601
SY510L EU	10	RAZOR TREAD PATTERN	0674326262079

EN388:2003



4 1 2 2



STANLEY

SANDY FOAM GRIPPER GLOVES

€ 7,52

SKU	SIZE	PALM	EAN
SY890L EU	10	SANDY FOAM DIPPED GRIP	0674326265056

EN388:2003



1 1 3 2



STANLEY

STICKY NITRILE DIPPED GRIPPER GLOVES

€ 5,00

- Nitrile Coating for grip and abrasion resistance
- 13 Gauge Nylon/Polyester Shell for a lightweight, breathable fit
- Elastic Cuff for a secure, comfortable fit

SKU	SIZE	PALM	EAN
SY580L EU	10	STICKY NITRILE DIPPED GRIP	0674326263571

EN388:2003



3 1 2 1



PROTECTIVE GLOVES

STANLEY

WINTER GRIPPER GLOVES

€ 13,18

- 10 Gauge Acrylic Thermal Shell
- ¾ Micro-foam Palm

SKU	SIZE	PALM	EAN
SY610L EU	10	WINTER GRIPPER GLOVES	0674326262123



STANLEY

FINGERLESS PERFORMANCE GLOVES

€ 15,16

- Rubberized Palm Overlays provide grip enhancement
- Foam Padded Knuckle Guard provides added protection
- Fingerless Design provides extreme dexterity

SKU	SIZE	PALM	EAN
SY640L EU	10	RUBBERIZED OVERLAYS	0674326262130



STANLEY

FRAMER PERFORMANCE GLOVES

€ 17,24

- Rubberized Palm Overlays provides grip enhancement
- Foam Padded Knuckle Guard provides added protection
- ¾ Short Finger Design provides extreme dexterity

SKU	SIZE	PALM	EAN
SY650L EU	10	RUBBERIZED OVERLAYS	0674326262147

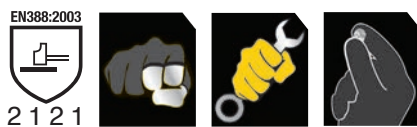

STANLEY

GENERAL PERFORMANCE GLOVES

€ 20,56

- Rubberized Palm Overlays provides grip enhancement
- Foam Padded Knuckle Guard provides added protection
- Reinforced Finger and Thumb improves wear life

SKU	SIZE	PALM	EAN
SY660L EU	10	RUBBERIZED OVERLAYS	0674326262154



STANLEY.**WATERPROOF GRIPPER GLOVES****€ 8,76**

- 13 Gauge nylon shell
- Fully coated waterproof latex coating.
- Sandy foam latex palm coating

SKU	SIZE	PALM	EAN
SY18 L EU	10	WATERPROOF GRIPPER GLOVES	0674326349015

EN388:2016



3 1 3 2 X

**STANLEY.****VIBRATION REDUCTION GLOVES****€ 51,20**

- Premium, Water & Oil Resistant for enhanced grip and durability
- Gel Padded Palm reduces stressful vibrations, increasing control
- Foam Padded Knuckle Guard provides added protection

SKU	SIZE	PALM	EAN
SY800 L EU	10	PADDED MEMORY FOAM OVERLAYS	0674326264059

EN388:2003



3 1 3 2

**STANLEY.****EXTREME PERFORMANCE GLOVES****€ 35,16**

- TPR Knuckle and Back of Hand Guard provides impact protection
- PVC Palm and Thumb Saddle Overlays adds durability
- Synthetic Leather Nail Guards for extra protection

SKU	SIZE	PALM	EAN
SY820L EU	10	RUBBERIZED OVERLAYS	0674326263861

EN388:2003



2 1 2 1

**STANLEY.****PERFORMANCE LEATHER HYBRID GLOVES****€ 31,36**

- Rugged Reverse Cowhide Finger & Palm Overlays provide extra grip.
- Lightweight, Breathable Spandex allows for a cool, comfortable fit.
- Terry Cloth Top of Thumb to quickly absorb perspiration.

SKU	SIZE	PALM	EAN
SY750L EU	10	LEATHER	0674326264028

EN388:2003



3 1 2 2



PROTECTIVE GLOVES

STANLEY

SPLIT LEATHER COWHIDE GLOVES

€ 17,31

- Elasticized Wrist for a snug and secure fit
- Double Stitching for added durability
- Keystone Thumb for comfort and added dexterity

SKU	SIZE	PALM	EAN
SY710L EU	10	SPLIT LEATHER	0674326262109

EN388:2003



4 1 4 3



STANLEY

PREMIUM A/B GRADE LEATHER WORK GLOVES

€ 30,54

- Elastic Back of Wrist for a snug and secure fit
- Double Stitching for added durability
- Keystone Thumb for comfort and added dexterity
- Double Palm Overlay for extra performance and durability

SKU	SIZE	PALM	EAN
SY740L EU	10	SPLIT LEATHER PALM OVERLAY	0674326263991

EN388:2003



3 1 2 2



STANLEY

WINTER RIGGER GLOVES

€ 15,84

- 40g Thinsulate™ Liner keeps hands warm
- ToughThread™ Double Stitching & Reinforced Finger Tips for greater durability
- Leather Knuckle Strap & Reinforced Safety Cuff provides extra protection

SKU	SIZE	PALM	EAN
SY780L EU	10	LEATHER	0674326262093

EN388:2003



3 1 3 3

3M
Thinsulate™
INSULATION

EN388:2003



3 1 3 3



STANLEY

HIPORA® MEMBRANE WATERPROOF GLOVES

€ 42,11

SKU	SIZE	PALM	EAN
SY840L EU	10	RUBBERIZED OVERLAYS	0674326262178

EN388:2003



3 1 2 1

3M
Thinsulate™
INSULATION



PROTECTIVE EYEWEAR

STANLEY

HALF FRAME PROTECTIVE EYEWEAR

€ 11,48

- Half Frame Wrap Around Lens
- 10 Base Curve
- Rubber Tipped Temples
- Soft, Rubber Nosepiece
- Polycarbonate Lens



SKU	LENS COLOR	EAN
SY150-1D	EU CLEAR	0674326262383
SY150-2D	EU SMOKE	0674326262215

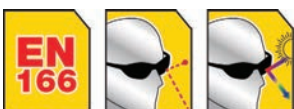

STANLEY

FRAMELESS PROTECTIVE EYEWEAR

€ 6,48

- Lightweight Design
- Soft Rubber Nosepiece
- Rubber Tipped Temples
- Polycarbonate Lens



SKU	LENS COLOR	EAN
SY120-1D	EU CLEAR	0674326264479
SY120-2D	EU SMOKE	0674326264486



STANLEY

FULL FRAME PROTECTIVE EYEWEAR

- Soft Rubber Brow-Pad
- Soft Rubber Nosepiece
- Rubber Tipped Temples
- Polycarbonate Lens



SKU	LENS COLOR	EAN	PRICE
SY180-2D EU	SMOKE	0674326264691	€ 12,60
SY180-9D EU	INDOOR/OUTDOOR	0674326264721	€ 14,04
SY180-YD EU	YELLOW MIRROR	0674326264714	€ 14,01

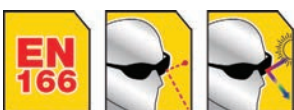

PROTECTIVE EYEWEAR & EARWAER

STANLEY

GOGGLES

€ 10,96

- Adjustable Strap
- Vented
- Full Coverage
- One Piece, Polycarbonate Lens

SKU	LENS COLOR	EAN
SY240-1D EU	CLEAR	0674326264875



STANLEY

AM/FM EAR DEFENDERS

€ 119,79

- Adjustable Headband allows for ideal fit
- Foam Filled Ear Cushions improve comfort
- LCD Panel includes click operation and tuning display
- 3.5 mm Auxiliary Jack allows the use of any audio device with headphone output (not Bluetooth capable)
- Accessory patch cable included

SKU	SNR	EAN
SY360 EU	31	0674326263472



STANLEY

PADDED EAR DEFENDERS

€ 14,72

- Adjustable Headband for added comfort
- Foam Filled Ear Cushions provide a comfortable fit
- Padded Headband for comfort during extended use

SKU	SNR	EAN
SY345C EU	26	0674326277875



PROTECTIVE GLOVES

PROTECTIVE GLOVES AGAINST MECHANICAL RISKS

THE EN388 STANDARD EXPLAINED: EN388:2003 - EN388:2011 - EN388:2016

EN388 is a piece of legislation which provides information about the mechanical resistance of safety gloves in a format which is easy to understand. Gloves which conform to EN 388 are rated using four numbers; these numbers tell you how resistant the gloves are to mechanical hazards. You can use this information to ensure that your workers are protected in an appropriate way.

EN388:2003
EN388:2011



ABCD

EN388:2016



ABCDE

- E - CUT TDM TEST
- D - PUNCTURE RESISTANCE
- C - TEAR RESISTANCE
- B - BLADE CUT RESISTANCE
- A - ABRASION RESISTANCE

Level	1	2	3	4	5
Abrasion Resistance No. of Cycles	100	500	2000	8000	-
Blade Cut Resistance Factor	1.2	2.5	5.0	10.0	20.0
Tear Resistance Newton	10	25	50	75	-
Puncture Resistance Newton	20	60	100	150	-
Cut TDM Test Newton	Not Tested				



EN388:2003



4131



POWERTOOL GLOVE GEL PALM - DPG33L EU

€ 34,36

Product Code DPG33L EU

Color Black/Green

EAN: 0674326273785

PROTECTIVE GLOVES

DEWALT

PERFORMANCE GLOVE HALF FINGER - DPG213L EU

€ 19,88

Product Code DPG213L EU

Color Black

EAN: 0674326273952

EN388:2003



2111



DEWALT

PERFORMANCE GLOVE 3 FINGER - DPG214L EU

€ 15,66

Product Code DPG214L EU

Color Black

EAN: 0674326273969

EN388:2003



2111



DEWALT

PERFORMANCE GLOVE FULL FINGER - DPG215L EU

€ 16,49

Product Code DPG215L EU

Color Black

EAN: 0674326273976

EN388:2003



2111



DEWALT

FRAMER GLOVE 3 FINGER - DPG24L EU

€ 30,79

Product Code DPG24L EU

Color Black/Green

EAN: 0674326273785

EN388:2003



4141





EAVY DUTY SYNTHETIC GLOVE PAD PALM - DPG21L EU € 33,20

Product Code DPG21L EU

Color: Black/Yellow

EAN: 0674326273747

EN388:2011



4414



FINGERLESS SYNTHETIC LEATHER PERFORMANCE - DPG23L EU € 28,18

Product Code DPG23L EU

Color: Black/Yellow

EAN: 0674326273723

EN388:2003



2141



PREM SPLIT COWHIDE LEATHER GLOVE - DPG41L EU € 16,89

Product Code DPG41L EU

Color: Black/Yellow

EAN: 0674326273754

EN388:2011



4414



LEATHER PERFORMANCE HYBRID - DPG216L EU € 21,00

Product Code DPG216L EU

Color: Black/Yellow

EAN: 0674326301112

EN388:2003



3121



PROTECTIVE GLOVES

DEWALT

EN388:2003



4121

NYLON NITRILE SMOOTH GRIPPER GLOVE - DPG66L EU € 6,68

Product Code DPG66L EU

Color: Black

EAN: 0674326273341



DEWALT

EN388:2016



2142X

TEXTURED RUBBER COATED GRIP GLOVE - DPG70L EU € 8,55

Product Code DPG70L EU

Color: Black/Yellow

EAN: 0674326273761



DEWALT

EN388:2003



4122

TOUCHSCREEN HPPE CUT 3 GLOVE - DPG800L EU € 25,40

Product Code DPG800L EU

Color: Black

EAN: 0674326291970



DEWALT

EN388:2003



2222

THERM GLOVE IN GLOVE 3/4 FIP GRIPPER - DPG737L EU € 14,53

Product Code DPG737L EU

Color: Black

EAN: 0674326301532



PROTECTIVE EYEWEAR & EARWAER



DEWALT

ADJUSTABLE EAR DEFENDERS

€ 40,38

- Protective spectacles

PRODUCT	CODE TYPE	EAN
DPG13HC EU	DPG13HC EU	0674326290676



PROTECTIVE EYEWEAR

DEWALT

CONCEALER™

€ 26,27

- Protective spectacles

PRODUCT	CODE TYPE	EAN
DP682-11D	EU DEWALT CONCEALER CLEAR AF EU	0674326273914

CLEAR



DEWALT

DOMINATOR™

€ 12,45

- Protective spectacles

PRODUCT	CODE TYPE	EAN
DP694-2D EU	DEWALT DOMINATOR SMOKE EU	0674326233154

SMOKE



DEWALT

ROUTER™

- Protective spectacles

PRODUCT	CODE TYPE	EAN	PRICE
DP696-2D EU	DEWALT ROUTER SMOKE EU	0674326239354	€ 13,94
DP696-FD EU	DEWALT ROUTER FIRE MIRROR EU	0674326259796	€ 15,81

SMOKE



CLEAR



DEWALT

CONTRACTOR PRO™

- Protective spectacles

PRODUCT	CODE TYPE	EAN	PRICE
DP652-1D EU	DEWALT CONTRACTOR PRO CLEAR EU	0674326222219	€ 4,98
DP652-2D EU	DEWALT CONTRACTOR PRO SMOKE EU	0674326273891	€ 7,14
DP652-9D EU	DEWALT CONTRACTOR PRO I/O EU	0674326222240	€ 7,10

SMOKE



+

CLEAR



I/O



DEWALT**PROTECTOR™**

- Protective spectacles

PRODUCT	CODE TYPE	EAN	PRICE
DPG54-1D EU	DEWALT PROTECTOR CLEAR EU	0674326216997	€ 4,98
DPG54-2D EU	DEWALT PROTECTOR SMOKE EU	0674326217017	€ 6,60

**DEWALT****REINFORCER™**

- Protective spectacles

PRODUCT	CODE TYPE	EAN	PRICE
DPG58-1D EU	DEWALT REINFORCER CLEAR EU	0674326217253	€ 6,43
DPG58-2D EU	DEWALT REINFORCER SMOKE EU	0674326273815	€ 6,60
DPG58-6D EU	DEWALT REINFORCER FIRE MIRROR EU	0674326280110	€ 8,38
DPG58-9D EU	DEWALT REINFORCER I/O EU	0674326280110	€ 7,22

**DEWALT****INFINITY™****€ 17,72**

- Protective spectacles

PRODUCT	CODE TYPE	EAN
DPG90S-7D EU	DEWALT INF SILVER/BLUE MIRROR EU	0674326273310

**DEWALT****STRUCTURE™****€ 6,06**

- Protective spectacles

PRODUCT	CODE TYPE	EAN
DPG93-2D EU	DEWALT STRUCTURE SMOKE EU	0674326277172



PROTECTIVE EYEWEAR

DEWALT

HDP™

€ 49,88

- Protective spectacles

PRODUCT	CODE TYPE	EAN
DPG99-2PD EU	DEWALT HDP, SMOKE POLARIZED EU	0674326288260



DEWALT

CROSSCUT™

- Protective spectacles

PRODUCT	CODE TYPE	EAN	PRICE
DPG100-1D EU	DEWALT CROSSCUT, CLEAR EU	0674326290171	€ 13,65
DPG100-2D EU	DEWALT CROSSCUT, SMOKE EU	0674326290188	€ 13,65
DPG100-9D EU	DEWALT CROSSCUT, I/O EU	0674326290195	€ 16,85



DEWALT

AUGER™

- Protective spectacles

PRODUCT	CODE TYPE	EAN	PRICE
DPG101-1D EU	DEWALT AUGER CLEAR EU	0674326288819	€ 13,65
DPG101-2D EU	DEWALT AUGER SMOKE EU	0674326288826	€ 10,70
DPG101-FD EU	DEWALT AUGER FIRE MIRROR	0674326290683	€ 17,80



DEWALT

RECIP™

- Protective spectacles

PRODUCT	CODE TYPE	EAN	PRICE
DPG102-1D EU	DEWALT RECIP CLEAR EU	0674326288192	€ 7,10
DPG102-2D EU	DEWALT RECIP SMOKE EU	0674326288208	€ 7,10



SHIRTS/T-SHIRTS

CASTLE
CLOTHING 

125: PENARTH HOODY

€ 63,79

Sizes: S - XXXL
100% acrylic fabric
Polyester fleece lining
Zip front closure
Two breast pockets
Angled side pockets
Packed 3 pieces/size

Colours: Green, Navy



CASTLE
CLOTHING 

126: PORTMAN SHACKET

€ 55,26

Size: S-XXXL
230gsm Microfleece outer
180gsm Lining
100% Polyester
Sherpa fleece lined
Padded sleeves
Full length front zip
Adjustable studded cuffs
2 Side entry pockets

Colours: Navy, Red



CASTLE
CLOTHING 

131: ELITE POLO SHIRT

€ 16,86

Sizes: S - XXL
100% cotton
Yarn dyed
Single chest pocket
Straight hem
Thick, durable and hardwearing

Colours: Black/Navy • Blue - Grey



SHIRTS/T-SHIRTS

CASTLE
CLOTHING

134: POLO SHIRT

€ 18,14

Sizes: S - XXL
50% polyester 50% cotton
Easy care fabric
Contrasting placket and side panels

Colours: 134-BK: Black



CASTLE
CLOTHING

143: HYDE SHIRT

€ 33,92

Sizes: S-XXXL
100% Cotton
Yarn dyed
Single chest pocket
Brushed finish
Thick, durable and hardwearing

Colours: Navy



CASTLE
CLOTHING

151: ELITE T-SHIRT

€ 13,87

Sizes: S - XXL
170 gram 100% polyester
Quick Drying, Lightweight, Breathable
Moisture Wicking
Excellent Colour Retention
Easy Care
Reflective Print to Shoulders

Colours: Black



HOODIES + BODYWARMERS

CASTLE
CLOTHING

177: HENDON HOODY

€ 33,92

Sizes: S - XXL
320 gram polyester cotton
Double layered contrast inner hood
Kangaroo pocket
Discreet embroidered logo
Bronze eyelets
Flat draw cord

Colours BK:Black • NB:Navy Blue • GREY



HOODIES + BODYWARMERS + WINDBREAKER

CASTLE
CLOTHING 

235: ELITE RIBBED BODYWARMER

€ 50,99

Sizes: S- XXL
Nylon rip-stop outer
Zipped handwarmer pockets
Thermofort insulation
Lightweight

Colours BK-Black



CASTLE
CLOTHING 

238: EASTON PULLOVER

€ 42,46

Sizes: S - XXL
340 gram sweater fleece
Hardwearing knitted marl fabric
Fleece inner
Zipped pockets

Colours: Navy • Green • Grey



CASTLE
CLOTHING 

275: DOWNHAM BODYWARMERS

€ 50,99

Sizes: S - XXL
Peach feel polyester
heavily padded
Fleece lined
Zipped handwarmer pockets
Zipped internal document pocket
Embroidery access

Colours: 275-Bk. Black • 275-NV. Navy



CASTLE
CLOTHING 

295: SUTHERLAND WINDBREAKER

€ 89,40

Sizes: S - XXL
100% Nylon / Hardwearing PU coated outer
Waterproof fabric to 3000mm
Breathable to 3000mvp
Taped seams / Windproof with fleece lining
Zipped side opening / Reflective print
Adjustable hood / Kangaroo pocket

Colour: Grey • Green • Black



BODYWARMERS + FLEECES + SOFTSHELLS

CASTLE
CLOTHING 

204: SELKIRK SOFTSHELLS

€ 42,46

Sizes: XS - XXXL
Water resistant, windproof and breathable fabric
Zipped front pockets
High stretch fabric
Adjustable cuffs
Fleece lined

Colours: 204-BK: Black • 204-NV: Navy



CASTLE
CLOTHING 

245: RUTLAND JACKET

€ 63,79

Sizes: S - XXL
100% Polyester
Hardwearing rip-stop fabric
Waterproof fabric to 2000mm
Breathable to 2000mvp
Windproof / Taped seams
Adjustable draw cord at waist
Concealed adjustable hood

Colour: Black



CASTLE
CLOTHING 

252: STANTON SOFTSHELL

€ 72,33

Sizes: S - XXL
Soft shell
Water resistant
Waterproof zips
Windproof
Breathable
Fleece lined

Colour: Black



HIGH VIS JACKETS - VEST

CASTLE CLOTHING

210: HI VIS WATERPROOF JACKETS

€ 78,73

Sizes: S - XXXL
Waterproof and windproof fabric. 100% polyester
Conforms to EN471 Class 3
Embroidery access. Two way zip
Concealed hood. Quilted lining. Taped seams

Colours: Saturn Yellow / Orange



CASTLE CLOTHING

225: HI VIS VEST

€ 7,04

Sizes: S - XXXL
100% Polyester
Velcro fastening
Conforms to EN471 Class 2

Colours: Orange, Yellow



CASTLE CLOTHING

251: HI VIS AIR REFLEX JACKET

€ 93,67

Sizes: S - XXXL
220 gm PU coated fabric
100% Polyester
Waterproof fabric to 6000mm
Breathable to 2000mvp
Windproof / Welded seams
Conforms to EN471 Class 3
Conforms to EN343 3:2
For-TEX fabric

Colour: Yellow



CASTLE CLOTHING

951 AIR REFLEX TROUSER

€ 59,53

Sizes: S - XXXL
220 gm PU coated polyester
100% Polyester
Waterproof fabric to 6000mm
Breathable to 2000mvp
Windproof / Welded seams
Conforms to EN471 Class 1
Conforms to EN343 3:2
For-TEX fabric

Colour: Yellow



CASTLE CLOTHING

265: HI VIS BOMBER JACKET

€ 76,60

Sizes: S - XXXL
100% Polyester
Waterproof
Windproof
Concealed hood
Quilt lined
Taped seams
EN471 Class 3

Colours: Orange, Yellow



JACKETS

CASTLE
CLOTHING 

234: HOLKHAM JACKETS

€ 44,59

Sizes: S - XXXL
Water resistant, windproof and breathable fabric
Zipped front pockets
High stretch fabric
Adjustable cuffs
Fleece lined
Hood with draw cords

Colours: Navy / Black



CASTLE
CLOTHING 

256 SNAPE JACKETS

€ 76,60

Sizes: S - XXL
Nylon rip-stop and softshell outer
Zipped handwarmer pockets
Zipped chest pockets
Adjustable cuffs
Thermofort insulation

Colours 256/BK: Black



CASTLE
CLOTHING 

299: CLEVELAND JACKETS

€ 93,67

Sizes: S - XXXL
Hardwearing oxford outer
100% polyester
Water resistant fabric to 2000mm
Reflective trim
Windproof
Internal pocket
Fleece lined

Colours: 299/BK: Black • 299/NV: Navy



RAINWEAR

CASTLE
CLOTHING 

220: FLEX WATERPROOF JACKETS

€ 46,73

Sizes: S - XXXL
Waterproof stretchable PU tricot fabric
Zip front with studded storm flap
Concealed hood
Large pockets with velcro®
Adjustable cuffs with velcro®
Welded seams

Colours: 220-NB: Navy Blue - 220-G: Olive Green



CASTLE
CLOTHING 

920: FLEX WATERPROOF TROUSERS

€ 27,52

Sizes: S - XXXL
Waterproof stretchable PU tricot fabric
Side access slits with velcro®
Ankle adjustment
Elasticated waist
Welded seams
Hip pockets

Colours: 920-NB: Navy Blue - 920-G: Olive Green



CASTLE
CLOTHING 

320: FLEX WATERPROOF COVERALLS

€ 72,33

Sizes: S - XXXL
Waterproof stretchable PU tricot fabric
Zip front with studded storm flap
Elasticated storm cuff
Large pockets with velcro®
Welded seams

Colours: Navy, Yellow



RAINWEAR

CASTLE
CLOTHING

221: AIR FLEX WATERPROOF BREATHABLE JACKETS

€ 59,53

Sizes: S - XXXL
fully waterproof
breathable PU tricot fabric
concealed hood
studded double storm flap
extremely lightweight
large pockets
welded seams
conforms to EN343 3:2

Colours: 221-NB: Navy Blue • 221-BL: Black
221-G: Olive Green



CASTLE
CLOTHING

921: AIR FLEX WATERPROOF BREATHABLE TROUSERS

€ 36,06

Sizes: S - XXXL
fully waterproof
breathable PU tricot fabric
ankle adjustment
extremely lightweight
welded seams
hip pockets
conforms to EN343 3:2

Colours: 221-NB: Navy Blue • 221-BL: Black
221-G: Olive Green



CASTLE
CLOTHING

521: AIR FLEX BIB'N BRACES

€ 50,99

Sizes: S - XXL
breathable PU tricot fabric
fully waterproof
zipped central chest pocket
extremely lightweight
ankle adjustment
welded seams
conforms to EN343 3:2

Colours: 521-NB: Navy Blue • 521-G: Olive Green



SHORTS



827: ELITE WORK SHORT

€ 36,06

Sizes: 28-44
235gsm Lightweight rip-stop fabric
65% Polyester | 35% Cotton
Tuff-Tex trim to main wear areas
Triple stitched seams
Deep double front pockets
Combat style side pockets
Screwdriver, knife, phone and pen pockets
YKK zip

Colour: grey



844: ENDURO WORK SHORTS

€ 36,06

Sizes: 28-44
235gsm
65% Polyester | 35% Cotton
Triple stitched crotch
Rip-stop fabric
Cargo style
Double stitched inseam
YKK zip

Colours: Black, Grey



TROUSERS



700: EXTREME WORK TROUSERS

€ 63,79

Sizes: 28-44
320 gram polyester / cotton canvas
Cordura® trim to main wear
Wide belt loops
Top loading knee pad pockets triple stitched
Detachable / tuck-away tool pockets
Multi pocketed
Id pocket
30 reg or 32.5 long

Colours: 700-BK: Black • 700-NV: Navy Blue



TROUSERS

CASTLE CLOTHING 

710: EXCEL WORK TROUSERS

€ 44,59

330 gram poly/cotton
Twotone
Triple stitched
YKKzip
Holster pockets
Kneepad pockets
Tufftex trim
Regular or longleg

Colours: 710-GB: Grey/Black



CASTLE CLOTHING 

711: PRO WORK TROUSERS

€ 42,46

Sizes: 28-48
330 gram polyester / cotton
Triple stitched
Double thickness on back pockets
Tuck away nail pockets
Knee pad pockets
Mobile pocket
30 reg or 32.5 long
34 extra long leg (black only) 30"-40"

Colours: 911-BK: Black • 911-NV: Navy • 911-GR: Grey



CASTLE CLOTHING 

715: PROFLEX TROUSERS

€ 59,53

Sizes: 28-48
260 gram
63% Polyester / 34% Cotton / 3% Spandex
Full stretch fabric
Slim fit
Tuck away Tuff-TEX reinforced
holster pockets
Top loading Tuff-TEX 2.0 knee
pad pockets
Tuff-TEX reinforced hem
Triple stitched
YKK zip

Colours: Black • Navy



CASTLE CLOTHING 

717: COMFORT WORK TROUSERS

€ 36,06

Sizes: 28-44
320 gram brushed polyester / cotton
Knee pad pockets
Concealed zip rear pocket
Hammer loop
Draw corded adjustable
elasticated waistband

Colours: 717-BK: Black •
717-GR: Grey



CASTLE
CLOTHING 

725: MOTION WORK TROUSERS

€ 63,79

Sizes: 28-44
250 gram
65% Polyester 35% Cotton
X-Motion polyamide stretch panels for superior comfort & flexibility
Abrasion resistant Tuff-TEX trim to main wear areas
Triple stitched seams for long lasting durability
YKK zips, Knee pad pockets, Easy access holster pockets
Secure zipped rear & cargo pockets
Rule pocket & numerous tool pockets
Leg lengths 30" & 32.5"

Colours: Grey



CASTLE
CLOTHING 

727: ELITE WORK TROUSERS

€ 50,99

Sizes: 28-44
210 gram poly/cotton
Lightweight rip-stop fabric
Tufftex trim to main wear areas
Adjustable waistband
Triple stitched
Multi-pocketed
Knee pad pockets
Reflective rear trim

Colours: 727-BK: Black



CASTLE
CLOTHING 

916: WORKFORCE TROUSER

€ 33,92

Sizes: 28-48
245 gram
Poly/cotton
Cargo style
Part elasticated waist
Knee pad pockets
Regular or long leg

Colours: 916-NV: Navy • 916-BK: Black



CASTLE
CLOTHING 

715: PROFLEX TROUSER

€ 59,53

Sizes: 28-48
260 gram
Poly/cotton/elastane
Full stretch fabric
Slim fit
Triple stitched seams
Tuck away Tuff-TEX reinforced holster pockets
Top loading Tuff-TEX 2.0 knee pad pockets
Tuff-TEX reinforced hem
YKK zip

Leg lengths: Regular 30" • Long 32.5" • Extra Long 35" (Only 30" - 40")

Colours: Black • Grey • Navy



TROUSERS

CASTLE
CLOTHING 

901: COMBAT TROUSERS

€ 36,06

Sizes: 28-44
240 gram polyester / cotton
Zip fly style
Drawstring bottom
Six pocket continental style
Leg length 32.5

Colours:

Camouflage: Green W=WOODLAND • Grey U=URBAN • Blue NU= NIGHT URBAN
901-NV: Navy • 901-BK: Black • 901-G: Olive Green



Woodland

Urban

Night Urban



901-NV:
Black

901-NV:
Olive Green

901-NV
Navy

CHILDRENS WORKWEAR

CASTLE CLOTHING 

333: TEARAWAY JUNIOR COVERALLS

€ 29,66

Sizes: 1-2 year / 2-3 year / 3-4 year / 5-6 year / 7-8 year / 9-10 year / 11-12 year / 13 year
 Hardwearing polyester / cotton
 Full velcro® front fastening
 Two breast pockets with velcro®
 Elasticated action back
 Side pockets with access slits



Colours:
 333-RB: Royal Blue
 333-NB: Navy Blue
 333-R: Red

CASTLE CLOTHING 

711J: PRO WORK JUNIOR TROUSER

€ 31,79

Sizes: 3-4 / 5-6 / 7-8 / 9-10 / 11-12 / 13 year
 330 gram polyester / cotton
 Triple stitched
 Double thickness on back pockets
 Tuck away nail pockets
 Knee pad pockets
 Mobile pocket



Colour: BK: Black

COVERALLS

CASTLE CLOTHING 

344: STUD FRONT BOILER SUITS

€ 42,46

Sizes: 36-54
 240 gram polyester / cotton
 Single piece / elasticated / action back
 Concealed press studs
 Two studded breast pockets
 Two back pockets



Colours 344-NB: Navy Blue • 344-SG: Spruce Green

CASTLE CLOTHING 

544: BIB 'N BRACES

€ 40,33

Sizes: 32-50
 240 gram polyester / cotton
 Zip concealed under placket
 Access slits with press studs
 Two side pockets
 Rule pocket
 Knee pad pocket
 Large back patch pocket



Colours 544-NV: Navy Blue

CASTLE CLOTHING 

318: WORKFORCE BOILER SUIT

€ 38,19

Sizes: S-XXL
 210 gram polyester / cotton
 Two studded breast pockets
 Single piece elasticated back
 Concealed press studs
 One back pocket



Colours NB: Navy Blue

ACCESSORIES

CASTLE
CLOTHING

401: THINSULATE WATCH HAT

€ 7,47

One size
40 gram thinsulate lined
100% acrylic
Packed per 12

Colours:
Brown, Beige, Blue
black, navy blue



CASTLE
CLOTHING

410: BEANIE

€ 11,73

Sizes: One Size
Thinsulate lined
Chunky knit

Colours: Assorted colours



CASTLE
CLOTHING

412: REFLECTIVE BEANIE

€ 11,73

Sizes: one size
3M Thinsulate
100% Acrylic
Lined with soft microfleece for
increased comfort
Reflective thread and fluorescent fibre
for increased visibility during

Colours: Yellow



CASTLE
CLOTHING

418: NECK WARMER

€ 9,60

Sizes: one size
240 gram polyester, cotton
Single piece, elasticated, action back
Zip breast, pen, rule pockets
Two back pockets, one with velcro®

Colours: Black



CASTLE
CLOTHING

601: THINSULATE FLEECE GLOVES

€ 13,87

Onze size
40 gram thinsulate lined
Polyester Fleece
Packed per 12



CASTLE
CLOTHING

602: THINSULATE KNITTED GLOVES

€ 13,87

One size
40 gram thinsulate lined
100% acrylic
Packed per 12



603: THINSULATE FINGERLESS GLOVES € 13,87

One size
40 gram thinsulate lined
100% acrylic
Packed per 12



779: TUFFSTUFF KNEEPADS € 8,32

E20 high elastic EVA
Twenty piece segmented design
Increased comfort and flexibility



FIRST AID



MEZZO FIRST AID KITS

First aid for up to 10/20/50 persons available in the Mezzo Dispenser.
This meets the minimum approved code of practice.

Data:
1001045 * 10 Persons Kit * EAN: 5025766110768 * € 36,72
1001046 * 20 Persons Kit * EAN: 5025766110744 * € 49,20
1001047 * 50 Persons kit * EAN: 5025766131176 * € 76,17

Contents:
20 / 40 / 60 Individually wrapped plaster
6 / 9 / 12 Medium sterile dressings
2 / 3 / 4 Large sterile dressings
2 / 4 / 6 Triangular bandage
12 / 12 / 12 Safety pins
10 / 10 / 20 Individually wrapped alcohol free wipes
2 / 4 / 6 Eye pads
2 / 4 / 6 pairs disposable gloves
First Aid guidance leaflet
Wall mounting bracket

**10
PERS**
1001045



**20
PERS**
1001046



**50
PERS**
1001047



FIRST AID



VIVO VAN & TRUCK FIRST AID KIT

€ 16,87

Contains recommended first aid components for travelling employees, with additional contents. Can be located onto the existing green box bracket or installed with the new secure fitting bracket as supplied.

Data:
1019033 EAN: 5025766131435

Contents:
6 x Alcohol Free Wipes / 2 x Conforming bandage
5 x Sterile eye wash pods 20ml / 2 x Finger stalls
2 x Gloves (pair) / 1 x Guidance leaflet
1 x Large dressing / 1 x Microporous tape
5 x Non adherent dressings / 12 x Safety pins
1 x Scissors / 2 x Triangular bandage
20 x Washproof plasters



1009004: MEZZO BURNS FIRST AID DISPENSER

€ 73,41

The Mezzo Burns Dispenser contains Astroplast and Hydrogel burns dressings. Sterikool is made up of 96 parts water, 3 parts Polyvinyl Alcohol and one part Sodium Borate in a non woven carrier. Sterikool reduces pain in partial thickness burns, by protecting the exposed nerve endings from the environment. Hydrogel moisturises, cools and soothes, minimising trauma and help prevent infection. Non-adherent and non-toxic.

Contents:
1 x Guidance Leaflet
7 x Non-Adherent Dressings
5 x Burn/Wound Lint Pads
2 x Burn Gels
3 x Conforming Bandages
2 x Burn Dressings
3 x Sterikool Burn Rolls
2 x Gloves (Pairs)
1 x Scissors

EAN: 5025766110492



2405006: STERILE EYEWASH PODS 20 ML - 25 PIECES

€ 21,20

Can be used to replace sterile water in eye care dispensers.
Bottles are fitted with tamper-proof caps.
Saline Pods – contain Sodium Chloride

EAN: 5025766120989



1005005: MEZZO EYEWASH FIRST AID KIT - DISPENSER

€ 46,83

Our Standard Dispenser complies, plus includes additional recommended HSE items. Rapid response is required for any eye injuries sustained in the workplace.

Contents:

2 x Eyewash 500ml
1 x Eye Pad
2 x Eyewash Pods 20ml
4 x Saline Pods 5ml
1 x Soft Tissues (Pack)
1 x Mirror

EAN: 5025766110713



1005006: PICCOLO EYEWASH DISPENSER

€ 35,70

Compact eyewash kit ideal for eye irrigation in the home, small office or isolated places at work

Contents:

10 x Eyewash Pods 20ml
5 x Saline Pods 5ml
5 x No 16
2 x Eye Pads
1 x Mirror

EAN: 5025766125182



2403008: 500 ML STERILE EYEWASH

€ 5,32

Contain Sodium Chloride Buffer Solution.
Restores the eye to its natural pH.
Can be used to replace sterile water in eye care dispensers.
Bottles are fitted with tamper-proof caps.





1007019 PULL 'N' OPEN PLASTER DISPENSER

€ 31,74

1007019: Dispenser with WATERPROOF plasters,
60 pieces, 2,5 x 7,2cm

EAN: 5025766133675

Refill: Price: € 19,67
1203013: REFILL WATERPROOF PLASTERS
2,5 x 7,2 cm

EAN: 5025766736

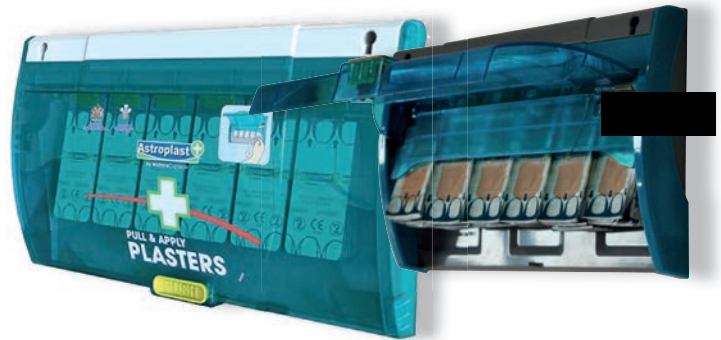

1007020 PULL 'N' OPEN PLASTER DISPENSER

€ 32,52

1007020: Dispenser FABRIC plasters, 60 pieces, 2,5x7,2cm

EAN: 5025766133675

Refill: Price: € 25,47
1201010: REFILL FABRIC PLASTERS
2,5 x 7,2 cm

EAN: 5025766133743

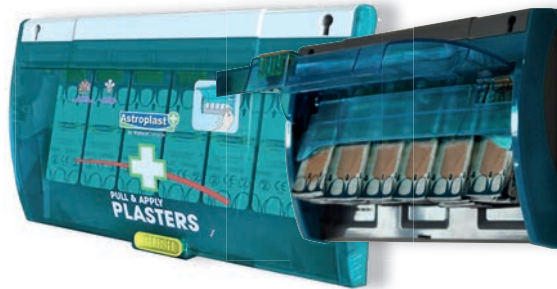

1007021 PULL 'N' OPEN PLASTER DISPENSER

€ 31,74

1007021: Dispenser BLUE DETECTABLE plasters,
60 pieces, 2,5 x 7,2 cm

EAN: 5025766133446

Refill: Price: € 19,67
1205010: REFILL BLUE DETECTABLE PLASTERS
2,5 x 7,2 cm

EAN: 5025766133750



ADHESIVE TAPE

2001011
2,5 cm x 5m
Price: € 1,68



FIRST AID

WASHPROOF TAPE

2002003
2,5 cm x 5 m
Price: € 1,29



BLUE TAPE

2003001
2,5 cm x 5 m
Price: € 1,32



MICROPOROUS TAPE

2005015
2,5 cm x 5 m
Price: € 1,50



PLASTERS ASSORTMENT

1211001: WASHPROOF STANDARD ASSORTED - 150 PIECES
EAN: 5425009856710
Price: € 19,60

1207001: HEAVY DUTY STANDARD ASSORTED - 150 PIECES
EAN: 5425009856642
Price: € 19,60

1215001: BLUE DETECTABLE EXTENSION PLASTERS - 50 PIECES
Price: € 17,60

1213001: BLUE STANDARD ASSORTED - 150 PIECES
Price: € 17,46

1213014: BLUE STANDARD PLASTERS - 7,2 * 2,5 CM * 150 PIECES
EAN: 5025766139356
Price: € 17,46

1806002: FINGERBOBS - BLUE - 6 PIECES
Price: € 4,38

1203013: WATERPROOF plasters, 2,5x7,2cm, 100 pieces
Price: € 41,28

1201010: FABRIC plasters, 2,5 x 7,2cm, 100 pieces
Price: € 30,96



DISPLAYS

JCB

UNDERWEAR DISPLAY



JCB

CLOTHING RACK



JCB

ROTATING MOVABLE SOCK DISPLAY



JCB

SOCK FLOOR DISPLAY



DISPLAYS

ROUGHNECK®

DISPLAY ROUGHNECK



ROUGHNECK®

TOOL DISPLAY ROUGHNECK





SHOE FLOOR DISPLAY



SHOE COUNTER DISPLAY



SHOE FLOOR DISPLAY



FOLDING SAW COUNTER DISPLAY



SQUARES COUNTER DISPLAY



SQUARES DISPLAY





ECONEX BV

WATERSTRAAT 24, 9620 ZOTTEGEM - BELGIUM • TEL.:+32 9 360 60 13 • FAX:+32 9 360 60 14

ADMIN@ECONEX.BE - WWW.ECONEX.BE